

ALUMILUX™

ARCHITECTURAL LIGHTING



ALUMILUX™



Our state of the art Alumilux collection of LED luminaries is manufactured to the highest standards of technology available. Comprised of sleek, architectural designs and machined out of solid stock aluminum, these pieces have applications in both residential and commercial installation. Alumilux is a full range of products that include interior and exterior sconces, pendant, ceiling mounts, bath vanities and step lights. The line is effortlessly married into contemporary and transitional settings since it is both abundant in selections and minimalist in their design.

TABLE OF CONTENTS

Sconces	01
Ceiling & Pendants	61
Pathways	69

LEGEND



LED Lighting



ADA Compliant



Wet Location



Damp Location



Rotatable Light



Up/Down Lighting



Adjustable



Title 24



Dimmable

SCONCES

INTERIOR & EXTERIOR

Bring the outdoors inside with our line of Architectural Essentials high quality interior and exterior wall sconces. European in design and machined out of blocks of solid Aluminum, these sconces have both the look and quality expected for the discriminate buyer. High powered LEDs create dramatic light effects and most are approved for wet location applications.





- Indirect Wall Lighting creates light pattern effect
- ADA Compliant
- Directionally adjustable in field
- ETL & cETL wet location listed, IP65 rated
- Available in 120V and 220V-277V*
- Driver located within fixture
- 35,000 hours rated life
- Color Temp: 3000K
- CRI: 80+



*220V & 277V available for special order

Model	E41386
Dimensions	4.5"W x 4.5"H x 3"E, 2.25" HCO
Lamping	4W LED PCB (integrated) LED lm: 360, Delivered lm: 75 CRI 80+, 3000K 120V
Size Options	
Certifications	
Available Finishes	





E41386-WT

SA - Satin Aluminum, WT - White

- ETL & cETL wet location listed, IP65 rated
- ADA Compliant
- Machined Aluminum
- 3000K Color Temperature
- CRI 90+
- Dimmable with Triac dimmer
- Interior/Exterior wall sconces
- Indirect backlight

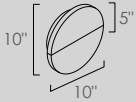

*220V & 277V available for special order

Model	E41280
Dimensions	10"W x 10"H x 1.5"E, 5" HCO
Lamping	15W LED (integrated) Rated lm: 1050, Delivered lm: 831 CRI 90+, 3000K 120V
Size Options	
Certifications	
Available Finishes	 SA WT





E41280-WT

SA - Satin Aluminum, WT - White

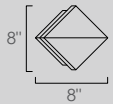

*220V & 277V available for special order

Model	E41284
Dimensions	8"W x 8"H x 1.5"E, 5.5" HCO
Lamping	10W LED (integrated) Rated lm: 700, Delivered lm: 658 CRI 90+, 3000K 120V
Size Options	
Certifications	
Available Finishes	



E41284-WT

BZ - Bronze, WT - White

- ETL & cETL wet location listed, IP65 rated
- ADA Compliant
- Can be mounted horizontally/vertically
- Machined Aluminum
- 3000K Color Temperature
- CRI 90+
- Dimmable with Triac dimmer



*220V & 277V available for special order

Model	E41290
Dimensions	5.25"W x 18"H x 2.75"E, 9" HCO
Lamping	7W LED (integrated) Rated lm: 490, Delivered lm: 35 CRI 90+, 3000K 120V
Size Options	
Certifications	
Available Finishes	



E41290-BZ

BKSA - Black/Satin Aluminum, BZ - Bronze



E41292-BKSA



E41294-BZ

*220V & 277V available for special order

Model	E41292	E41294
Dimensions	5.25"W x 24"H x 2.75"E, 12" HCO	6"W x 30"H x 2.75"E, 15" HCO
Lamping	11W LED (integrated) Rated lm: 770, Delivered lm: 58 CRI 90+, 3000K 120V	15W LED (integrated) Rated lm: 1050, Delivered lm: 75 CRI 90+, 3000K 120V
Size Options		
Certifications		
Available Finishes		

BKSA - Black/Satin Aluminum, BZ - Bronze

- ETL & cETL wet location listed, IP65 rated
- Available in various lengths and finishes
- Cast and Machined Aluminum
- 3000K Color Temperature
- CRI 80+

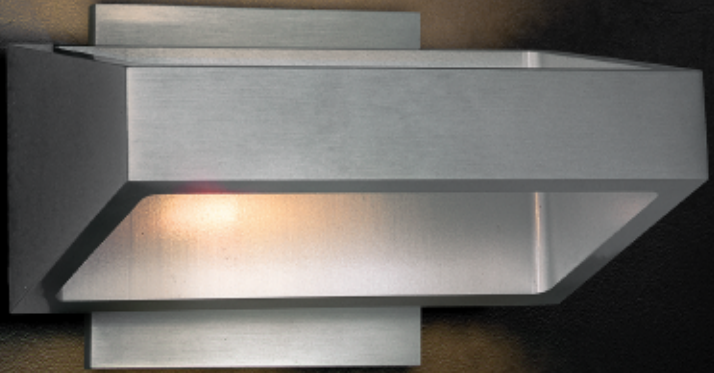

*220V & 277V available for special order

Model	E41302
Dimensions	7.25"W x 4.5"H x 5.25"E, 2.25" HCO
Lamping	5.4W LED PCB (integrated) Rated lm: 540, Delivered lm: 445 CRI 80+, 3000K 120V
Size Options	
Certifications	
Available Finishes	 SA WT



E41302-WT

SA - Satin Aluminum, WT - White



E41304-SA



E41305-SA

*220V & 277V available for special order

Model	E41304	E41305
Dimensions	8"W x 4.5"H x 4.25"E, 2.25"HCO	15.75"W x 4.5"H x 4.25"E, 2.25" HCO
Lamping	6W LED PCB (integrated) LED lm: 320, Delivered lm: 140 CRI 80+, 3000K 120V	8.1W LED PCB (integrated) Rated lm: 310, Delivered lm: 310 CRI 80+, 3000K 120V
Size Options		
Certificates		
Available Finishes	<p>SA</p>	

SA - Satin Aluminum

- ETL & cETL wet location listed, IP65 rated
- ADA Compliant
- Machined Aluminum
- 3000K Color Temperature
- CRI 90+
- Dimmable with Triac dimmer
- Indirect light



*220V & 277V available for special order

Model	E41335
Dimensions	9.75"W x 14.25"H x 2.75"E, 7" HCO
Lamping	15W LED (integrated) Rated lm: 1050, Delivered lm: 51 CRI 90+, 3000K 120V
Size Options	
Certifications	
Available Finishes	





E41335-WT

BKSA - Black/Satin Aluminum, WT - White

- ETL & cETL wet location listed, IP65 rated
- ADA Compliant
- Machined Aluminum
- 3000K Color Temperature
- Adjustable wall-lighting effect
- Up/Down light

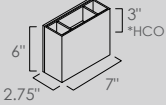

*220V & 277V available for special order

Model	E41328
Dimensions	7"W x 6"H x 2.75"E, 3" HCO
Lamping	6W COB LED (integrated) LED lm: 420, Delivered lm: 344 CRI 90+, 3000K 120V
Size Options	
Certifications	
Available Finishes	



E41328-WT

SA - Satin Aluminum, WT - White

- Adjustable Wall Lighting Effect
- Up/Down Light
- ETL & cETL wet location listed, IP65 rated
- Driver located within fixture
- 35,000 hours rated life
- Color Temp: 3000K
- CRI: 90+



*Adjustable face plate to direct light

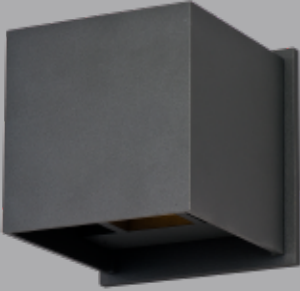

E41308-BZ

*220V & 277V available for special order

Model	E41308
Dimensions	4.5"W x 4.5"H x 4.25"E, 2.25" HCO
Lamping	6W LED PCB (integrated) Rated lm: 420, Delivered lm: 316 CRI 80+, 3000K 120V
Size Options	
Certifications	
Available Finishes	 BZ SA

BZ - Bronze, SA - Satin Aluminum



- Indirect Wall Lighting
- ADA Compliant
- ETL & cETL wet location listed, IP65 rated
- Title 24 listed
- Driver located within fixture
- 35,000 hours rated life
- Color Temp: 3000K
- CRI: 90+



E41307-WT



E41307-SA

*220V & 277V available for special order

Model	E41307
Dimensions	4.25"W x 16"H x 3.5"E, 12.5"HCO
Lamping	5 x 1W LED PCB (integrated) LED lm: 500, Delivered lm: 432 CRI 90+, 3000K 120V
Size Options	
Certifications	
Available Finishes	

SA - Satin Aluminum, WT - White

- ETL & cETL wet location listed, IP65 rated
- Can be mounted horizontally and vertically
- Up/Down Light
- Title 24 listed
- Driver located within fixture
- 35,000 hours rated life
- Color Temp: 3000K
- CRI: 90+
- ADA Compliant, low profile design



*220V & 277V available for special order

Model	E41310
Dimensions	6.75"W x 4.25"H x 1.75"E, 2.25" HCO
Lamping	10.8W LED PCB (integrated) Rated lm: 756, Delivered lm: 504 CRI 90+, 3000K 120V
Size Options	
Certifications	
Available Finishes	 BZ SA



E41310-SA

BZ - Bronze, SA - Satin Aluminum

- ETL & cETL wet location listed, IP65 rated
- ADA Compliant
- Driver located within fixture
- 35,000 hours rated life
- Color Temp: 3000K
- CRI: 80+





E41524-WT



E41526-BZ

*220V & 277V available for special order

Model	E41524	E41526
Dimensions	4.25"W x 13.75"H x 3.5"E, 11.75" HCO	4.25"W x 23.5"H x 3.5"E, 11.75" HCO
Lamping	2 x 4W LED PCB (integrated) Rated lm: 560, Delivered lm: 503 CRI 90+, 3000K 120V	2 x 4W LED PCB (integrated) Rated lm: 560, Delivered lm: 480 CRI 90+, 3000K 120V
Size Options	<p>13.75" 11.75" *HCO 4.25" 3.5"</p>	<p>23.5" 11.75" *HCO 4.25" 3.5"</p>
Certifications		
Available Finishes	<p>BZ WT</p>	

BZ - Bronze, WT - White

- ETL & cETL wet location listed, IP65 rated
- ADA Compliant
- Machined Aluminum
- 3000K Color Temperature
- CRI 90+
- Dimmable with Electronic Low Voltage dimmer

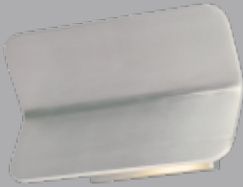

E41309-SA

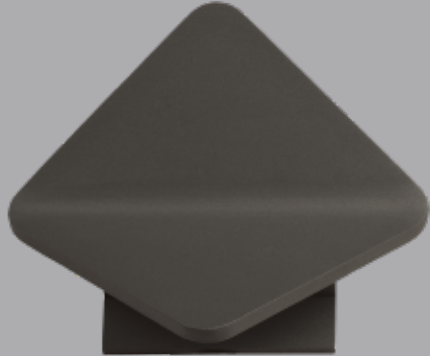

E41318-BZ

*220V & 277V available for special order

Model	E41309	E41318
Dimensions	8"W x 4.75"H x 2.75"E, 2.5" HCO	14"W x 6.75"H x 3.5"E, 3.44" HCO
Lamping	6W LED PCB (integrated) Rated lm: 420, Delivered lm: 362 CRI 80+, 3000K 120V	6W LED PCB (integrated) Rated lm: 420, Delivered lm: 428 CRI 80+, 3000K 120V
Size Options		
Certifications		
Available Finishes	<p>SA</p>	<p>BZ SA</p>

BZ - Bronze, SA - Satin Aluminum

- ETL & cETL wet location listed, IP65 rated
- Available in various sizes and finishes
- Coordinating wall sconce available
- Machined Aluminum
- 3000K Color Temperature
- CRI 90+
- Dimmable with Electronic Low Voltage dimmer





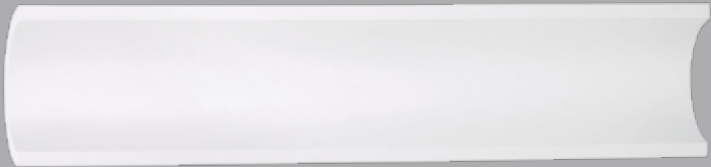





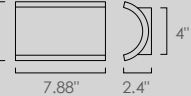
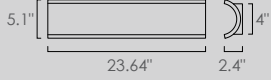

E41486-SA



E41488-WT

*220V & 277V available for special order

Model	E41486	E41488
Dimensions	7.88"W x 5.1"H x 2.4"E, 4.7" HCO	23.64"W x 5.1"H x 2.4"E, 12" HCO
Lamping	16W LED PCB (integrated) Rated lm: 1120, Delivered lm: 380 CRI 90+, 3000K	30W LED PCB (integrated) Rated lm: 2100, Delivered lm: 1390 CRI 90+, 3000K
Size Options	5.1"  7.88" 2.4" 4"	5.1"  23.64" 2.4" 4"
Certifications	  	   
Available Finishes	 BZ  SA  WT	

BZ - Bronze, SA - Satin Aluminum, WT - White

- ETL & cETL wet location listed, IP65 rated
- Machined Aluminum
- 3000K Color Temperature
- CRI 90+
- Dimmable with Electronic Low Voltage dimmer
- Backlight and downlight
- Indirect lighting



E41497-BZ



E41499-WT

*220V & 277V available for special order

Model	E41497	E41499
Dimensions	8"W x 20"H x 4"E, 16" HCO	10"W x 28"H x 4.25"E, 24" HCO
Lamping	24W LED PCB (integrated) Rated lm: 1680 CRI 90+, 3000K 120V	28W LED PCB (integrated) Rated lm: 1960 CRI 90+, 3000K 120V
Size Options		
Certifications		
Available Finishes		

BZ - Bronze, SA - Satin Aluminum, WT - White



- ADA Compliant
- Low profile design available in 6" and 9" widths
- ETL & cETL wet location listed, IP65 rated
- Available in 120V and 220V-277V*
- Driver located within fixture
- 35,000 hours rated life
- Color Temp: 3000K
- CRI: 80+



*220V & 277V available for special order

Model	E41500
Dimensions	6"W x 6"H x 1.5"E, 3" HCO
Lamping	5W LED PCB (integrated) Rated lm: 350 CRI 90+, 3000K 120V
Size Options	
Certifications	
Available Finishes	



E41500-BZ

BZ - Bronze, SA- Satin Aluminum, WT - White

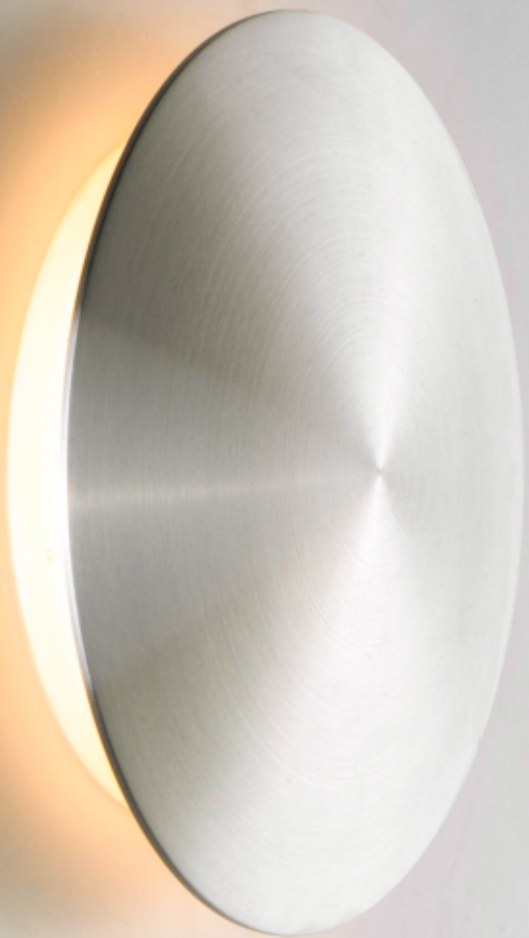

- ETL & cETL wet location listed, IP65 rated
- ADA Compliant
- Machined Aluminum
- 3000K Color Temperature
- CRI 90+
- Dimmable with Triac dimmer



*220V & 277V available for special order

Model	E41334
Dimensions	15.75"W x 9.25"H x 1.75"E, 6.75" HCO
Lamping	21W LED (integrated) LED lm: 1470, Delivered lm: 1432 CRI 90+, 3000K 120V
Size Options	
Certifications	
Available Finishes	



E41334-SA

BZ - Bronze, SA - Satin Aluminum, WT - White

- Low profile design available in 6" and 9" widths
- ADA Compliant
- ETL & cETL wet location listed, IP65 rated
- Driver located within fixture
- 35,000 hours rated life
- Color Temp: 3000K
- CRI: 80+



*220V & 277V available for special order

Model	E41329
Dimensions	4.5"W x 4.5"H x 0.75"E, 3.25" HCO
Lamping	8W LED PCB (integrated) Rated lm: 560, Delivered lm: 70 CRI 90+, 3000K 210V
Size Options	
Certifications	
Available Finishes	



E41329-WT

SA - Satin Aluminum, WT - White

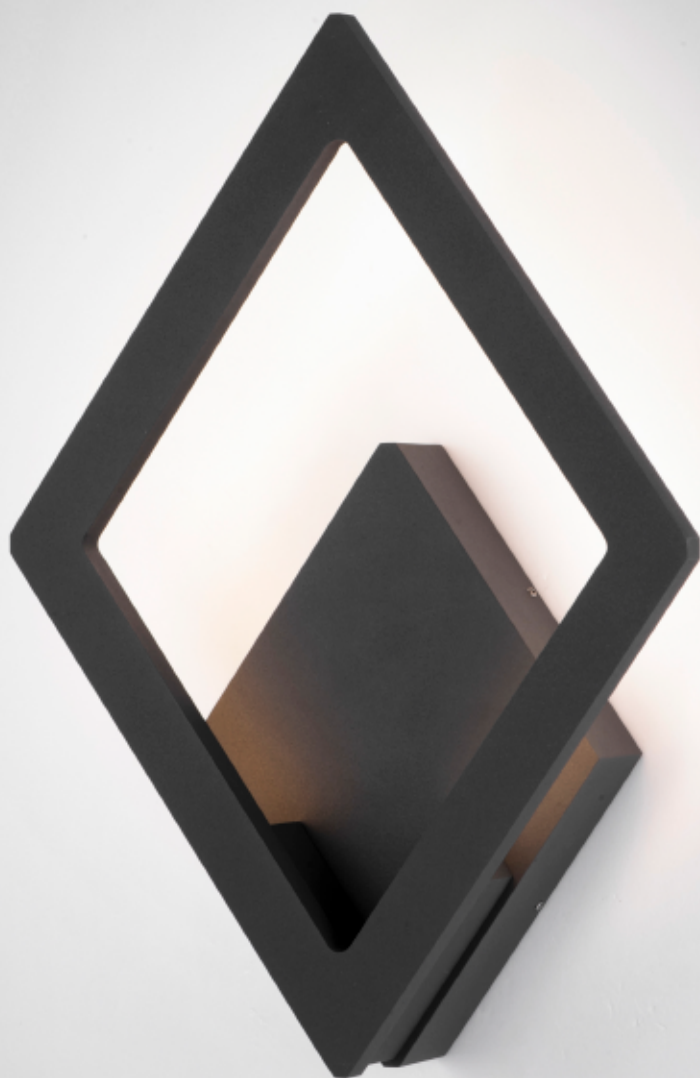

- ETL & cETL wet location listed, IP65 rated
- ADA Compliant
- 3000K Color Temperature
- CRI 90+
- Dimmable with Electronic Low Voltage dimmer
- Indirect Lighting



E41493-SA



E41495-WT

*220V & 277V available for special order

Model	E41493	E41495
Dimensions	10"W x 14.25"H x 3.25"E, 9.5" HCO	13.5"W x 19.25"H x 3.25"E, 14" HCO
Lamping	21W LED PCB (integrated) Rated lm: 1470, Delivered lm: 945 CRI 90+, 3000K 120V	25W LED PCB (integrated) Rated lm: 1750, Delivered lm: 1370 CRI 90+, 3000K 120V
Size Options		
Certificates		
Available Finishes		

BZ - Bronze, SA - Satin Aluminum, WT - White

- ETL & cETL wet location listed, IP65 rated
- Dimmable with Electronic Low Voltage dimmer
- Cast and Machined Aluminum
- 3000K Color Temperature
- CRI 90+



*220V & 277V available for special order

Model	E41373
Dimensions	7"W x 8.5"H x 2.5"E, 4.25"HCO
Lamping	7W LED PCB (integrated) LED lm: 490, Delivered lm: 460 CRI 90+, 3000K 120V
Size Options	
Certifications	
Available Finishes	



E41373-WT

SA - Satin Aluminum, WT - White

- Available in various shapes and finishes
- Cast and Machined Aluminum
- 3000K Color Temperature
- CRI 80+
- Interior/Exterior wall sconces

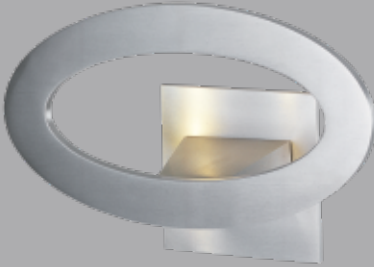

E41300-SA

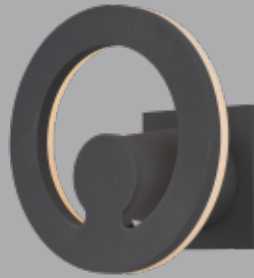

E41321-BZ

*220V & 277V available for special order

Model	E41300	E41321
Dimensions	10"W x 8"H X 3.5"E, 5" HCO	7.75"W x 7.75"H x 4.5"E, 3.72" HCO
Lamping	7 x 1W LED PCB (integrated) Rated lm: 700, Deilvered lm: 367 CRI 80+, 3000K 120V	28 x 8.4W LED PCB (integrated) Rated lm: 560, Delivered lm: 440 CRI 80+, 3000K 120V
Size Options		
Certifications		
Available Finishes	 BZ SA	

BZ - Bronze, SA - Satin Aluminum

- Combine pieces to create wall light pattern
- ADA Compliant
- ETL & cETL wet location listed, IP65 rated
- Driver located within fixture
- 35,000 hours rated life
- Color Temp: 3000K
- CRI: 80+



E41534-BZ
4-Light

*220V & 277V available for special order

Model	E41534
Dimensions	4.75"W x 4.75"H x 3.5"E, 2.5" HCO
Lamping	4 x 3W LED PCB (integrated) Rated lm: 840, Delivered lm: 450 CRI 90+, 3000K 120V
Size Options	
Certifications	
Available Finishes	 BZ

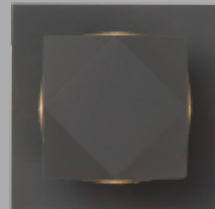

E41534-BZ

BZ - Bronze

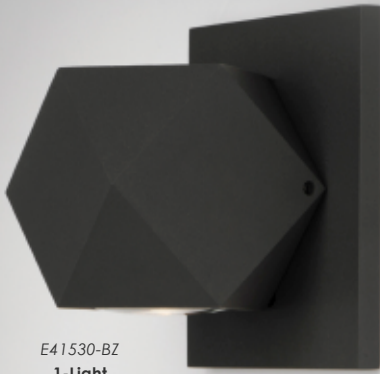

E41530-BZ
1-Light



E41532-BZ
2-Light

*220V & 277V available for special order

Model	E41530	E41532
Dimensions	4.75"W x 4.75"H x 3.5"E, 2.5" HCO	4.75"W x 4.75"H x 3.5"E, 2.5" HCO
Lamping	1 x 3W LED PCB (integrated) Rated lm: 210, Delivered lm: 135 CRI 80+, 3000K 120V	2 x 3W LED PCB (integrated) Rated lm: 420, Delivered lm: 270 CRI 90+, 3000K 120V
Size Options		
Certifications		
Available Finishes	 BZ	

BZ - Bronze

- ETL & cETL wet location listed, IP65 rated
- ADA Compliant
- Machined Aluminum
- 3000K Color Temperature
- CRI 90+
- Dimmable with Triac dimmer
- Indirect light



*220V & 277V available for special order

Model	E41330
Dimensions	6.25"W x 7.75"H x 2.25"E, 4.75" HCO
Lamping	8W COB LED (integrated) LED lm: 560, Delivered lm: 337 CRI 90+, 3000K 120V
Size Options	
Certifications	
Available Finishes	



E41330-BZ

BZ - Bronze, SA - Satin Aluminum

"Adjustable sphere for light direction"

- ETL & cETL wet location listed, IP65 rated
- ADA Compliant
- Machined Aluminum
- 3000K Color Temperature
- Adjustable wall-lighting effect
- Up/Down light



E41326-WT

*220V & 277V available for special order

Model	E41326
Dimensions	4.25"W x 4.25"H x 3.5"E, 3.5" HCO
Lamping	4W LED PCB (integrated) Rated lm: 280, Delivered lm: 140 CRI 90+, 3000K 120V
Size Options	
Certifications	
Available Finishes	

SA - Satin Aluminum, WT - White

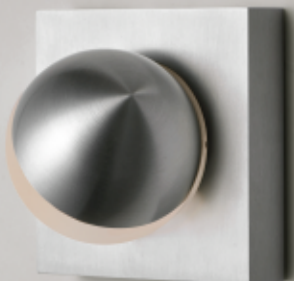
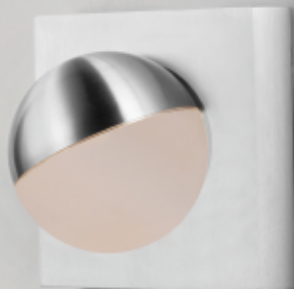
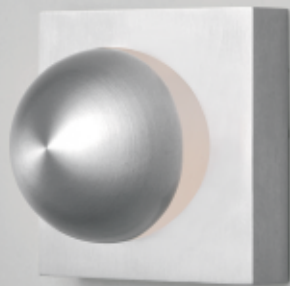

- Adjustable face plate for lighting direction



- ETL & cETL wet location listed, IP65 rated
- Adjustable face plate for lighting direction
- Indirect lighting
- 220V & 277V available for special order

Model	E41333
Dimensions	5"W x 7"H x 2.75"E, 3.5"HCO
Lamping	8W LED PCB (integrated) LED lm: 560, Delivered lm: 170 CRI 90+, 3000K 120V
Size Options	
Certifications	
Available Finishes	



E41333-WT

SA - Satin Aluminum, WT - White





1-Light
E41540-WT

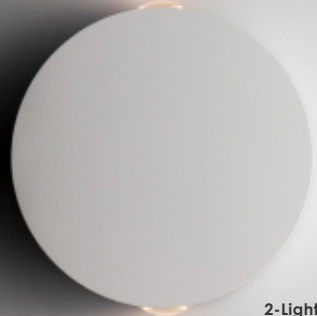

2-Light
E41542-WT

*220V & 277V available for special order

Model	E41540	E41542
Dimensions	4.75"W x 5"H x 1.5"E, 2.5" HCO	4.75"W x 5"H x 1.5"E, 2.5" HCO
Lamping	1 x 4W LED PCB (integrated) Rated lm: 280, Delivered lm: 320 CRI 90+, 3000K 120V	2 x 4W LED PCB (integrated) Rated lm: 560, Delivered lm: 683 CRI 90+, 3000K 120V
Size Options		
Certifications		
Available Finishes		

SA - Satin Aluminum, WT - White

- Combine pieces to create wall light pattern
- ADA Compliant
- Low profile design available in 6" and 9" widths
- ETL & cETL wet location listed, IP65 rated
- Driver located within fixture
- 35,000 hours rated life
- Color Temp: 3000K
- CRI: 80+

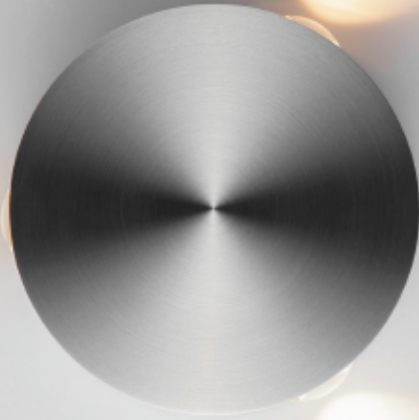

3-Light
E41544-SA

*220V & 277V available for special order

Model	E41544
Dimensions	4.75"W x 5"H x 1.5"E, 2.5" HCO
Lamping	3 x 4W LED PCB (integrated) Rated lm: 840, Delivered lm: 1150 CRI 90+, 3000K 120V
Size Options	
Certifications	
Available Finishes	

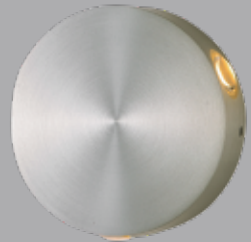

E41544-SA

SA - Satin Aluminum, WT - White

- Adjustable face plate to direct light
- ETL & cETL wet location listed, IP65 rated
- ADA Compliant
- Driver located within fixture
- 35,000 hours rated life
- Color Temp: 3000K
- CRI: 80+



*220V & 277V available for special order

Model	E41374
Dimensions	4.75"W x 4.75"H x 2.5"E, 2.25" HCO
Lamping	4W LED PCB (integrated) LED lm: 360, Delivered lm: 106 CRI 80+, 3000K 120V
Size Options	
Certifications	
Available Finishes	



E41374-BZ

BZ - Bronze, SA - Satin Aluminum

*Adjustable face plate to direct light



E41373-WT

*220V & 277V available for special order

Model	E41375
Dimensions	6.25"W x 6.25"H x 3.25"E, 3.25" HCO
Lamping	4W LED PCB (integrated) Rated lm: 360, Delivered lm: 280 CRI 90+, 3000K 120V
Size Options	
Certifications	
Available Finishes	

BZ - Bronze, SA - Satin Aluminum

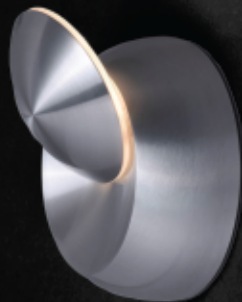
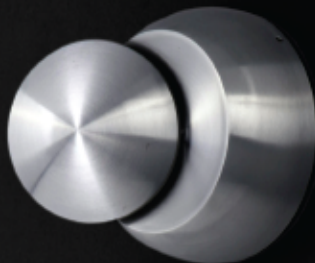
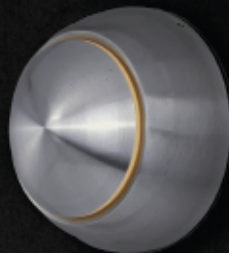

- Low profile design available in 6" and 9" widths
- ETL & cETL wet location listed, IP65 rated
- ADA Compliant
- Available in 120V and 220V-277V*
- Driver located within fixture
- 35,000 hours rated life
- Color Temp: 3000K
- CRI: 80+





E41502-WT



E41504-SA

*220V & 277V available for special order

Model	SM451502	SM451504
Dimensions	6.25"W x 6.25"H x 2.75"E, 3.25" HCO	7.75"W x 7.75"H x 2.25"E, 4" HCO
Lamping	8W LED PCB (integrated) Rated lm: 560, Delivered lm: 500 CRI 90+, 3000K 120V	12W LED PCB (integrated) Rated lm: 840, Delivered lm: 800 CRI 90+, 3000K 120V
Size Options		
Certificates		
Available Finishes		

BZ - Bronze, SA- Satin Aluminum, WT - White

- Adjustable face plate to direct light
- ADA Compliant
- Low profile design available in 6" and 9" widths
- ETL & cETL wet location listed, IP65 rated
- Driver located within fixture
- 35,000 hours rated life
- Color Temp: 3000K
- CRI: 80+





E41376-WT



E41378-WT

*220V & 277V available for special order

Model	E41376	E41378
Dimensions	6"W x 6"H x 2"E, 3"HCO	9"W x 9"H x 2.25"E
Lamping	4W LED PCB (integrated) LED lm: 360, Delivered lm: 110 CRI 80+, 3000K 120V	5W LED PCB (integrated) LED lm: 500, Delivered lm: 295 CRI 80+, 3000K 120V
Size Options	<p>6" 2"</p>	<p>9" 2.25"</p>
Certificates		
Available Finishes	<p>WT</p>	

WT - White



E41381-WT

*220V & 277V available for special order

Model	E41380
Dimensions	5.25"W x 5.25"H x 1.75"E, 2.75" HCO
Lamping	6W LED PCB (integrated) Rated lm: 600, Delivered lm: 295 CRI 80+, 3000K 120V
Size Options	
Certifications	
Available Finishes	

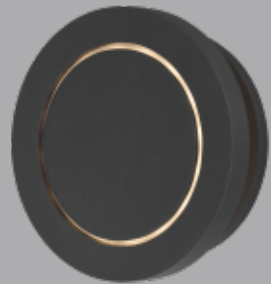

E41380-BZ

BZ - Bronze, WT - White

- Indirect Wall Lighting and additional Decorative, Direct Light
- ADA Compliant, low profile design available in 5.25", 7", and 11.75" widths
- ETL & cETL wet location listed, IP65 rated
- Driver located within fixture
- 35,000 hours rated life
- Color Temp: 3000K
- CRI: 80+

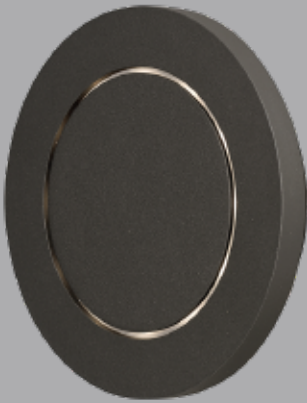







E41381-BZ

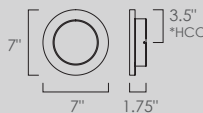
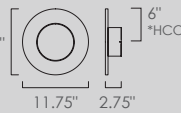

E41382-WT

*220V & 277V available for special order

Model	E41381	E41382
Dimensions	7"W x 7"H x 1.75"E, 3.5" HCO	11.75"W x 11.75"H x 2.75"E, 6" HCO
Lamping	8W LED PCB (integrated) Rated lm: 800, Delivered lm: 505 CRI 80+, 3000K 120V	15W LED PCB (integrated) Rated lm: 1500, Delivered lm: 1250 CRI 80+, 3000K 120V
Size Options	7"  3.5" *HCO 7" 1.75"	11.75"  6" *HCO 11.75" 2.75"
Certifications	  	
Available Finishes	  BZ WT	

BZ - Bronze, WT - White

- Can be mounted horizontally and vertically
- Indirect Wall Lighting creates light pattern effect
- ETL & cETL wet location listed, IP65 rated
- Driver located within fixture
- 35,000 hours rated life
- Color Temp: 3000K
- CRI: 80+



*220V & 277V available for special order

Model	E41385
Dimensions	9"W x 7.5"H x 4.25"E, 4.25"HCO
Lamping	5W LED PCB (integrated) LED lm: 500, Delivered lm: 290 CRI 80+, 3000K 120V
Size Options	
Certifications	
Available Finishes	 WT



E41385-WT

WT - White

- Cast and Machined Aluminum
- ADA Compliant
- 3000K Color Temperature
- CRI 90+
- Coordinating landscape lighting available (page 83)



E41047-WT

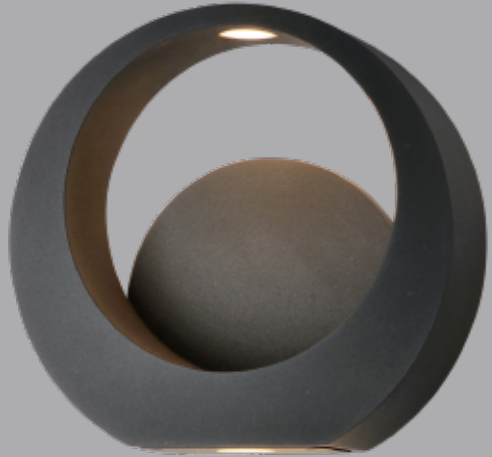

E41048-BZ

*220V & 277V available for special order

Model	E41047	E41048
Dimensions	7.75"W x 7.5"H x 2.75"E, 5"HCO	13.75"W x 13.75"H x 2.75"E, 11"HCO
Lamping	9W LED PCB (integrated) LED lm: 630, Delivered lm: 550 CRI 90+, 3000K 120V	19W LED PCB (integrated) LED lm: 1330, Delivered lm: 680 CRI 90+, 3000K 120V
Size Options		
Certifications		
Available Finishes		

BZ - Bronze, WT - White

- Can be mounted horizontally and vertically
- ETL & cETL wet location listed, IP65 rated
- Available in 120V and 220V-277V*
- Driver located within fixture
- 35,000 hours rated life
- Color Temp: 3000K
- CRI: 80+



E41323-BZ



E41324-SA

*220V & 277V available for special order

Model	E41323	E41324
Dimensions	6"W x 4.25"H x 7.25"E, 2.16"HCO	17.75"W x 4.25"H x 7.25"E, 2.16"HCO
Lamping	2.7W LED PCB (integrated) LED Im: 190, Delivered Im: 154 CRI 80+, 3000K 120V	8.1W LED PCB (integrated) LED Im: 560, Delivered Im: 547 CRI 80+, 3000K 120V
Size Options		
Certificates		
Available Finishes		

BZ - Bronze, SA - Satin Aluminum

- Machined Aluminum
- Collection fixture coordinating landscape lighting (page 79)
- ADA Compliant
- 3000K Color Temperature
- CRI 90+
- Dimmable with Electronic Low Voltage dimmer
- Additional downlight

- Available in various shapes and finishes
- Cast and Machined Aluminum
- 3000K Color Temperature
- CRI 80+
- Interior/Exterior wall sconces



E41368-WT

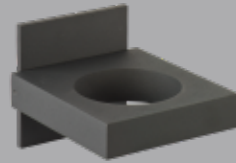

E41319-BZ

*220V & 277V available for special order

Model	E41368	E41319
Dimensions	5.75"W x 16"H x 3.25"E, 8" HCO	5.25"W x 4.25"H x 6"E, 2.16" HCO
Lamping	18W LED PCB (integrated) Rated lm: 1260, Delivered lm: 820 CRI 90+, 3000K 120V	3W LED PCB (integrated) Rated lm: 210, Delivered lm: 91 CRI 80+, 3000K 120V
Size Options		
Certifications		
Available Finishes		

BZ - Bronze, SA - Satin Aluminum, WT - White

- ETL & cETL wet location listed, IP65 rated
- 35,000 hours rated life
- Color Temp: 3000K
- CRI: 90+



*220V & 277V available for special order

Model	E41490
Dimensions	9"W x 9"H x 4.25"E, 5.5" HCO
Lamping	9W LED PCB (integrated) Rated lm: 1260 CRI 90+, 3000K 120V
Size Options	
Certifications	
Available Finishes	 BZ



E41534-BZ

BZ - Bronze

- ETL & cETL wet location listed, IP65 rated
- Available in various shapes and finishes
- Cast and Machined Aluminum
- 3000K Color Temperature
- CRI 80+

- ETL & cETL wet location listed, IP65 rated
- Available in various sizes and finishes
- Coordinating wall sconce available
- Machined Aluminum
- 3000K Color Temperature
- CRI 90+
- Dimmable with Electronic Low Voltage dimmer

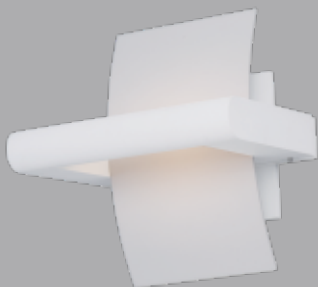

E41312-WT



E41485-BZ

*220V & 277V available for special order

Model	E41312	E41485
Dimensions	7"W x 8"H x 5.75"E, 3.75" HCO	7.88"W x 5.7"H x 3.9"E, 5" HCO
Lamping	6W LED PCB (integrated) Rated lm: 141, Delivered lm: 39 CRI 80+, 3000K 120V	18W LED PCB (integrated) Rated lm: 560, Delivered lm: 378 CRI 90+, 3000K 120V
Size Options		
Certifications		
Available Finishes	<p>WT</p>	<p>BZ SA WT</p>





BZ - Bronze, SA - Satin Aluminum, WT - White

- Adjustable dish to direct light
- Dimmable with Electronic Low Voltage dimmer
- Cast and Machined Aluminum
- 3000K Color Temperature
- CRI 90+
- Can be installed as either flush mount or wall sconce

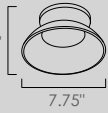

*Adjustable dish to direct light

*220V & 277V available for special order

Model	E41470
Dimensions	7.75"W x 4.25"H x 7.75"L
Lamping	15W LED (integrated) LED lm: 1350, Delivered lm: 1150 CRI 90+, 3000K 120V
Size Options	4.25"  7.75"
Certifications	 
Available Finishes	 WT



E41470-WT

WT - White

- Indirect wall lighting
- ADA Compliant
- ETL & cETL wet location listed, IP65 rated
- Available in 120V and 220V-277V*
- Driver located within fixture
- 35,000 hours rated life
- Color Temp: 3000K
- CRI: 80+



*220V & 277V available for special order

Model	E41388
Dimensions	6"W x 6"H x 2"E, 3"HCO
Lamping	1 x 10W LED (integrated) LED lm: 720, Delivered lm: 490 CRI 80+, 3000K 120V
Size Options	
Certifications	
Available Finishes	



E41388-SA

SA - Satin Aluminum, WT - White



*Adjustable light direction



- Coordinating pendants available
- Fixture pivots 180° to direct light
- Dimmable with Electronic Low Voltage dimmer
- Cast and Machined Aluminum
- 3000K Color Temperature
- CRI 90+



E41386-WT

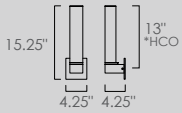

*220V & 277V available for special order

Model	E41460
Dimensions	4.25"W x 15.25"H x 4.25"E, 13"HCO
Lamping	8W LED PCB (integrated) LED lm: 560, Delivered lm: 430 CRI 90+, 3000K 120V
Size Options	
Certifications	
Available Finishes	

SA - Satin Aluminum, WT - White



- Coordinating pendants available
- Fixture pivots 180° to direct light
- Dimmable with Electronic Low Voltage dimmer
- Cast and Machined Aluminum
- 3000K Color Temperature
- CRI 90+



E41464-SA

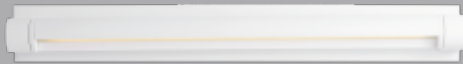

E41465-WT

*220V & 277V available for special order





Model	E41464	E41465
Dimensions	30"W x 4.5"H x 4.25"E, 2.25"HCO	36"W x 4.5"H x 4.25"E, 2.25"HCO
Lamping	15W LED PCB (integrated) LED lm: 1050, Delivered lm: 580 CRI 90+, 3000K 120V	20W LED PCB (integrated) LED lm: 1400, Delivered lm: 750 CRI 90+, 3000K 120V
Size Options		
Certifications		
Available Finishes		

SA - Satin Aluminum, WT - White

*Light pivots 180°

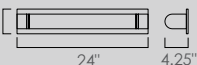

*220V & 277V available for special order

Model	E41463
Dimensions	24"W x 4.5"H x 4.25"E, 2.25"HCO
Lamping	10W LED (integrated) LED lm: 700, Delivered lm: 420 CRI 90+, 3000K 120V
Size Options	4.5" 
Certifications	 
Available Finishes	 SA  WT

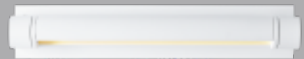

E41463-WT

SA - Satin Aluminum, WT - White



E41540-WT

*220V & 277V available for special order

Model	E41348
Dimensions	4.5"W x 96"H x 2.25"E, 48"HCO
Lamping	60W LED PCB (integrated) LED lm: 4200 CRI 80+, 3000K 120V
Size Options	
Certifications	
Available Finishes	

BZ - Bronze, SA - Satin Aluminum, WT - White

- ETL & cETL wet location listed, IP65 rated
- ADA Compliant
- Indirect back lighting
- Long lengths available (up to 8")
- Cast and Machined Aluminum
- 3000K Color Temperature
- CRI 80+

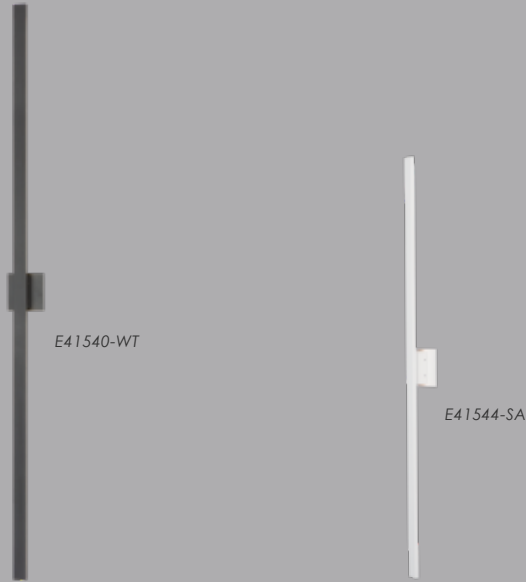

*220V & 277V available for special order

Model	E41346	E41344
Dimensions	4.5"W x 73"H x 2.25"E, 36.5"HCO	4.5"W x 51"H x 2.25"E, 25.5"HCO
Lamping	50W LED PCB (integrated) LED lm: 3500 CRI 90+, 3000K 120V	30W LED PCB (integrated) LED lm: 2100 CRI 90+, 3000K 120V
Size Options		
Certifications		
Available Finishes		

BZ - Bronze, SA- Satin Aluminum, WT - White



- Coordinating pendants available
- Available in various finishes
- Arm rotates 270°
- ETL & cETL wet location listed, IP65 rated
- Dimmable with Electronic Low Voltage dimmer
- Cast and Machined Aluminum
- 3000K Color Temperature
- CRI 90+



E41440-WT



*Adjustable
 *Dimmable with triac dimmer
 *220V & 277V available for special order

Model	E41440
Dimensions	4.75"W x 31"H x 4"E, 25"HCO
Lamping	7W LED PCB (integrated) LED lm: 490, Delivered lm: 420 CRI 90+, 3000K 120V
Size Options	
Certifications	
Available Finishes	

SA - Satin Aluminum, WT - White

CEILING

Available in various shapes and colors, this collection of pendants and flush mounts provide a full range of streamlined, architectural design. Cast and extruded pieces of aluminum provide illumination that complement the sleek styling of commercial applications and minimalist modern design. Be it over a table or a work station, these versatile products direct lighting for both task and decorative uses.



- Coordinating outdoor wall sconce
- Available in various shapes and finishes
- Dimmable with Electronic Low Voltage dimmer
- Machined Aluminum
- 3000K Color Temperature
- CRI 90+
- Available in 120V and 220V-277V*

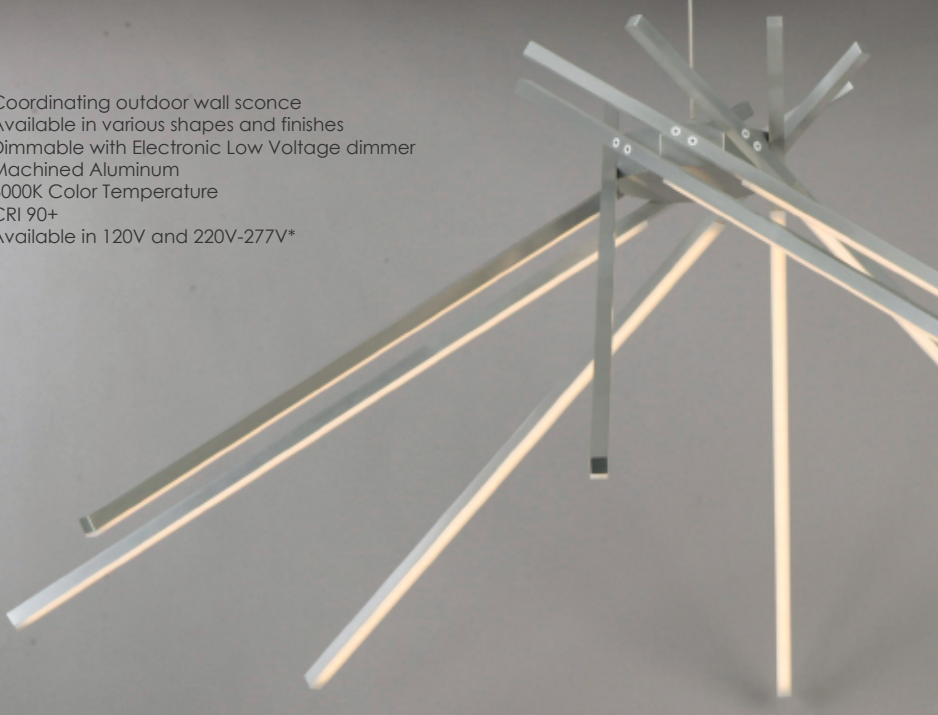

*220V & 277V available for special order

Model	E41443
Dimensions	44.5"D x 20.25"H, 135.25" Max OA
Lamping	23W LED PCB (integrated) LED Im: 1610, Delivered Im: 1495 CRI 90+, 3000K 120V
Size Options	
Certifications	
Available Finishes	 SA WT

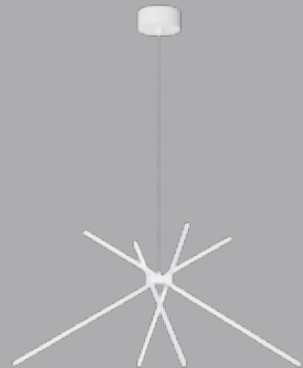

E41443-WT

SA - Satin Aluminum, WT - White

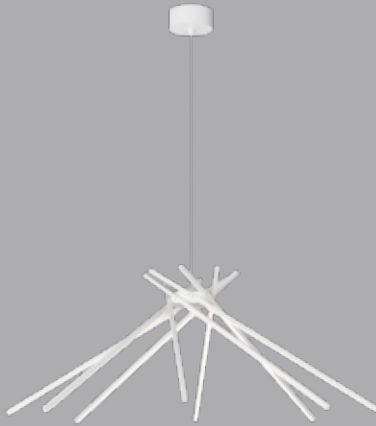

E41445-WT



E41446-SA

*220V & 277V available for special order

Model	E41445	E41446
Dimensions	44.75"D x 16.25"H, 138.5" Max OA	44.5"D x 20.25"H, 20.25" Max OA
Lamping	27W LED PCB (integrated) LED Im: 1890, Delivered Im: 1769 CRI 90+, 3000K 120V	60W LED PCB (integrated) LED Im: 4200, Delivered Im: 3932 CRI 90+, 3000K 120V
Size Options		
Certifications		
Available Finishes		

SA - Satin Aluminum, WT - White



- Coordinating wall sconce & vanities available on page 53
- Available in various lengths and finishes
- Dimmable with Electronic Low Voltage dimmer
- Machined Aluminum
- 3000K Color Temperature
- CRI 90+
- Available in 120V and 220V-277V*

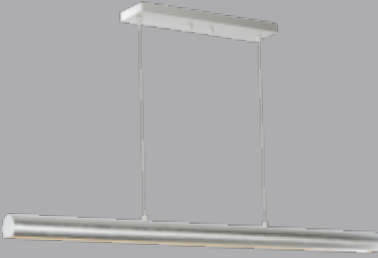

E41467-SA

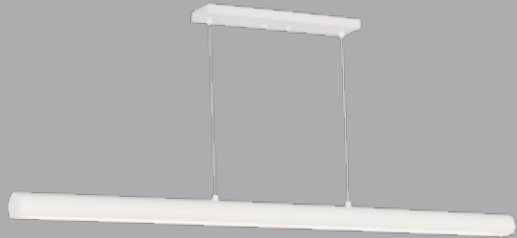

E41468-WT

*220V & 277V available for special order

Model	E41467	E41468
Dimensions	4.5"W x 2.75"H x 46.75"L, 122.5" Max OA	4.5"W x 2.75"H x 58.25"L, 122.5" Max OA
Lamping	30W LED PCB (integrated) Rated lm: 2100 CRI 90+, 3000K 120V	35W LED PCB (integrated) Rated lm: 2450 CRI 90+, 3000K 120V
Size Options		
Certifications		
Available Finishes		

SA - Satin Aluminum, WT - White



*220V & 277V available for special order

Model	E41484
Dimensions	4.5"W x 3"H x 17.25"L, 122" Max OA
Lamping	3 x 4W LED PCB (integrated) LED lm: 840, Delivered lm: 930 CRI 90+, 3000K 210V
Size Options	
Certifications	
Available Finishes	 WT

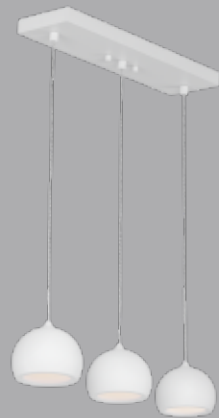

E41544-SA

WT - White

- Dimmable with Electronic Low Voltage dimmer
- Twisted 120V wire
- Machined Aluminum
- 3000K Color Temperature
- CRI 90+
- Available in 120V and 220V-277V*



E41544-SA

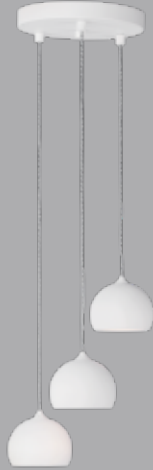

E41540-WT

*220V & 277V available for special order

Model	E41481	E41483
Dimensions	4.75"D x 3"H, 121.5" Max OA	10"D x 3.75"H, 122" Max OA
Lamping	4W LED PCB (integrated) LED Im: 360, Delivered Im: 310 CRI 90+, 3000K 120V	3 x 4W LED PCB (integrated) LED Im: 840, Delivered Im: 930 CRI 90+, 3000K 120V
Size Options	<p>121.5" *Max OA</p> <p>3"</p> <p>4.75"</p>	<p>122" *Max OA</p> <p>3.75"</p> <p>10"</p>
Certifications		
Available Finishes	<p>WT</p>	

WT - White

PATHWAYS

Provide safe and functional lighting along your paths by adding spot lighting and bollards. These machined aluminum products enhance the architectural elements of your home by using techniques like grazing and uplighting. Whether you choose to accentuate an object of interest or extend your living space, this collection has the sleek and slim profile to blend seamlessly into your pathways.







- 12V LED, compatible with landscape lighting
- ETL & cETL wet location listed, IP65 rated
- 35,000 hours rated life
- Color Temp: 3000K
- CRI: 80+
- Includes spike and concrete bolts



E41364-SA



Model	E41364
Dimensions	3"W x 34"H
Lamping	3W LED PCB (included) Delivered lm: 210 CRI 80+, 3000K 12V
Size Options	
Certifications	 
Available Finishes	  BZ SA

BZ - Bronze, SA - Satin Aluminum

- 12V LED, compatible with landscape lighting
- ETL & cETL wet location listed, IP65 rated
- 35,000 hours rated life
- Color Temp: 3000K
- CRI: 80+
- Includes spike and concrete bolts



E41350-SA



Model	E41350
Dimensions	3.5"W x 13.75"H
Lamping	3W LED MR16 (included) Delivered lm: 230 CRI 80+, 3000K 12V
Size Options	
Certifications	
Available Finishes	 BZ SA

BZ - Bronze, SA - Satin Aluminum





- ETL & cETL wet location listed, IP65 rated
- 12V LED; compatible with landscape lighting
- Available in various shapes
- Cast and Machined Aluminum
- 3000K Color Temperature
- CRI 90+
- Includes spike and concrete bolts



E41357-BK



E41358-BK

Model	E41357	E41358
Dimensions	5.75"W x 3.75"H	5.75"W x 4"H
Lamping	12W LED PCB (integrated) LED lm: 840, Delivered lm: 220 CRI 90+, 3000K 12V	9W LED PCB (integrated) LED lm: 630, Delivered lm: 250 CRI 90+, 3000K 12V
Size Options		
Certifications	 	
Available Finishes	 BK	

BK - Black

- 12V LED; compatible with landscape lighting
- Available in various finishes
- Cast and Machined Aluminum
- 3000K Color Temperature
- CRI 90+
- Includes spike and concrete bolts



E41370-GY



Model	E41370
Dimensions	5"W x 23.5"H x 5"L
Lamping	12W LED COB (integrated) LED lm: 840, Delivered lm: 450 CRI 90+, 3000K 12V
Size Options	
Certifications	
Available Finishes	

BZ - Bronze, SA - Satin Aluminum





- 12V LED, compatible with landscape lighting
- ETL & cETL wet location listed, IP65 rated
- 35,000 hours rated life
- Color Temp: 3000K
- CRI: 80+
- Includes spike and concrete bolts



E41365-SA

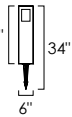

*220V & 277V available for special order

Model	E41365
Dimensions	6"W x 34"H
Lamping	6W LED PCB (integrated) LED lm: 420, Delivered lm: 216 CRI 80+, 3000K 12V
Size Options	23.75"  34" 6"
Certifications	 
Available Finishes	  BZ SA

BZ - Bronze, SA - Satin Aluminum

- ETL & cETL wet location listed, IP65 rated
- 12V LED, compatible with landscape lighting
- ETL & cETL wet location listed, IP65 rated
- 35,000 hours rated life
- Color Temp: 3000K
- CRI: 80+
- Includes spike and concrete bolts



E41363-BZ



Model	E41363
Dimensions	3.25"W x 34"H
Lamping	2W LED PCB (integrated) Delivered lm: 140 CRI 80+, 3000K 12V
Size Options	
Certifications	
Available Finishes	

BZ - Bronze, SA - Satin Aluminum

- 12V LED, compatible with landscape lighting
- ETL & cETL wet location listed, IP65 rated
- 35,000 hours rated life
- Color Temp: 3000K
- CRI: 80+
- Includes spike and concrete bolts



E41367-BZ



Model	E41367
Dimensions	3.25"W x 23.5"H x 6"L
Lamping	3W LED PCB (integrated) LED lm: 210, Delivered lm: 203 CRI 80+, 3000K 12V
Size Options	
Certifications	
Available Finishes	

BZ - Bronze, SA - Satin Aluminum

- Coordinating wall sconces on page 48
- 12V LED, compatible with landscape lighting
- ETL & cETL wet location listed, IP65 rated
- 35,000 hours rated life
- Color Temp: 3000K
- CRI: 80+
- Includes spike and concrete bolts



E41369-BZ



Model	E41369
Dimensions	5.25"W x 19.75"H x 7.25"L
Lamping	9.8W LED PCB (integrated) LED lm: 690, Delivered lm: 480 CRI 80+, 3000K 12V
Size Options	
Certifications	
Available Finishes	

BZ - Bronze, SA - Satin Aluminum





- 12V LED, compatible with landscape lighting
- ETL & cETL wet location listed, IP65 rated
- 35,000 hours rated life
- Color Temp: 3000K
- CRI: 80+
- Includes spike and concrete bolts



E41366-BZ



*220V & 277V available for special order

Model	E41366
Dimensions	4"W x 34"H
Lamping	5.4W LED PCB (integrated) LED lm: 420, Delivered lm: 298 CRI 80+, 3000K 12V
Size Options	23.75"  34" 4"
Certifications	 
Available Finishes	  BZ SA

BZ - Bronze, SA - Satin Aluminum

- 12V LED, compatible with landscape lighting
- ETL & cETL wet location listed, IP65 rated
- 35,000 hours rated life
- Color Temp: 3000K
- CRI: 80+
- Includes spike and concrete bolts

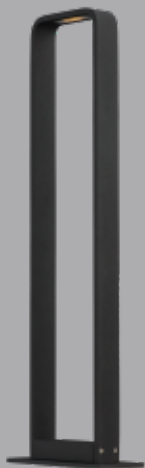

E41371-BZ







Model	E41371
Dimensions	3.25"W x 24"H x 7"L
Lamping	3W LED PCB (integrated) LED lm: 210, Delivered lm: 176 CRI 80+, 3000K 12V
Size Options	
Certifications	
Available Finishes	 BZ SA

BZ - Bronze, SA - Satin Aluminum

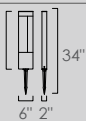

E41383-BZ



Model	E41383
Dimensions	2"W x 23.75"H x 6"L
Lamping	8.4W LED (integrated) LED lm: 588, Delivered lm: 400 CRI 90+, 3000K 12V
Size Options	23.75"  34" 6" 2"
Certifications	 
Available Finishes	  BZ WT

BZ - Bronze, WT - White

- ETL & cETL wet location listed, IP65 rated
- Coordinating outdoor wall sconces available
- Available in various finishes
- Cast and Machined Aluminum
- 3000K Color Temperature
- CRI 90+
- Includes spike and concrete bolts





Model	E41049
Dimensions	4"W x 13.5"H x 13.75"L
Lamping	4W LED PCB (integrated) Rated lm: 840, Delivered lm: 610 CRI 90+, 3000K 12V
Size Options	<p>13.5" 24.25" 13.75" 4"</p>
Certifications	
Available Finishes	 BZ WT



E41049-WT

BZ - Bronze, WT - White

- 12V & 120V versions available
- Available in various shapes and finishes
- Cast and Machined Aluminum
- 3000K Color Temperature
- CRI 90+

- * Required for installation
- * Sold separately



E42400



E41403-BZ



E41404-SA

*12V - E41403, E41404 / 120V - E42403, E42404

Model	E41403 / E42403	E41404 / E42404
Dimensions	3.25"W x 3.25"H x 1"E, 3"HCO	3.25"W x 3.25"H x 1"E, 3"HCO
Lamping	2W LED PCB (integrated) LED lm: 180, Delivered lm: 70 CRI 90+, 3000K 12V / 120V	2W LED PCB (integrated) LED lm: 180, Delivered lm: 70 CRI 90+, 3000K 12V / 120V
Size Options		
Certifications		
Available Finishes		

BZ - Bronze, SA - Satin Aluminum, WT - White



