

Contemporary Lighting™

PRODUCT NAME: Cage 1LT Pendant
ITEM NUMBER: E20573

Please consult your electrician for hanging fixture and wiring.

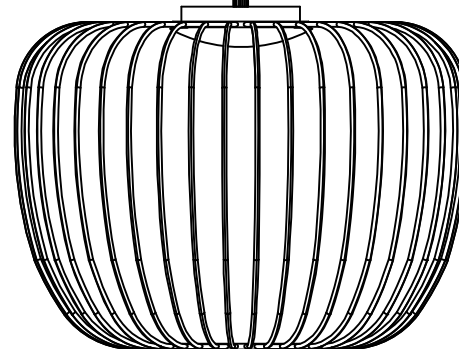
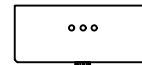

The fixture is designed to dim with a standard Triac forward phase dimmer. Dimming levels will vary by dimmer.

Below is a list of recommended dimmers:

- Lutron MACL-153M
- Lutron DVL-153P
- Lutron SCL-153P
- Leviton IPL06-10Z
- Leviton 6674-POW

Due to inrush current wattage should not exceed 150 watts of product for a 600 watt dimmer.

WARNING: Wires need to be connected to driver found in canopy and should not be connected directly to power source or a short may occur.

Bulbs (Not included):1*LED*7.2W

IMPORTANT: Turn off the power at the main fuse or circuit breaker box before starting installation



Bracket (A)



Screws(B)



Mounting Screws(C)

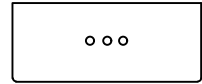

Canopy(D)

Locate all hardware & components before discarding packaging

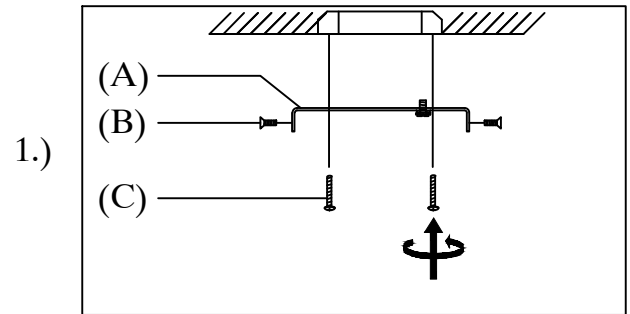
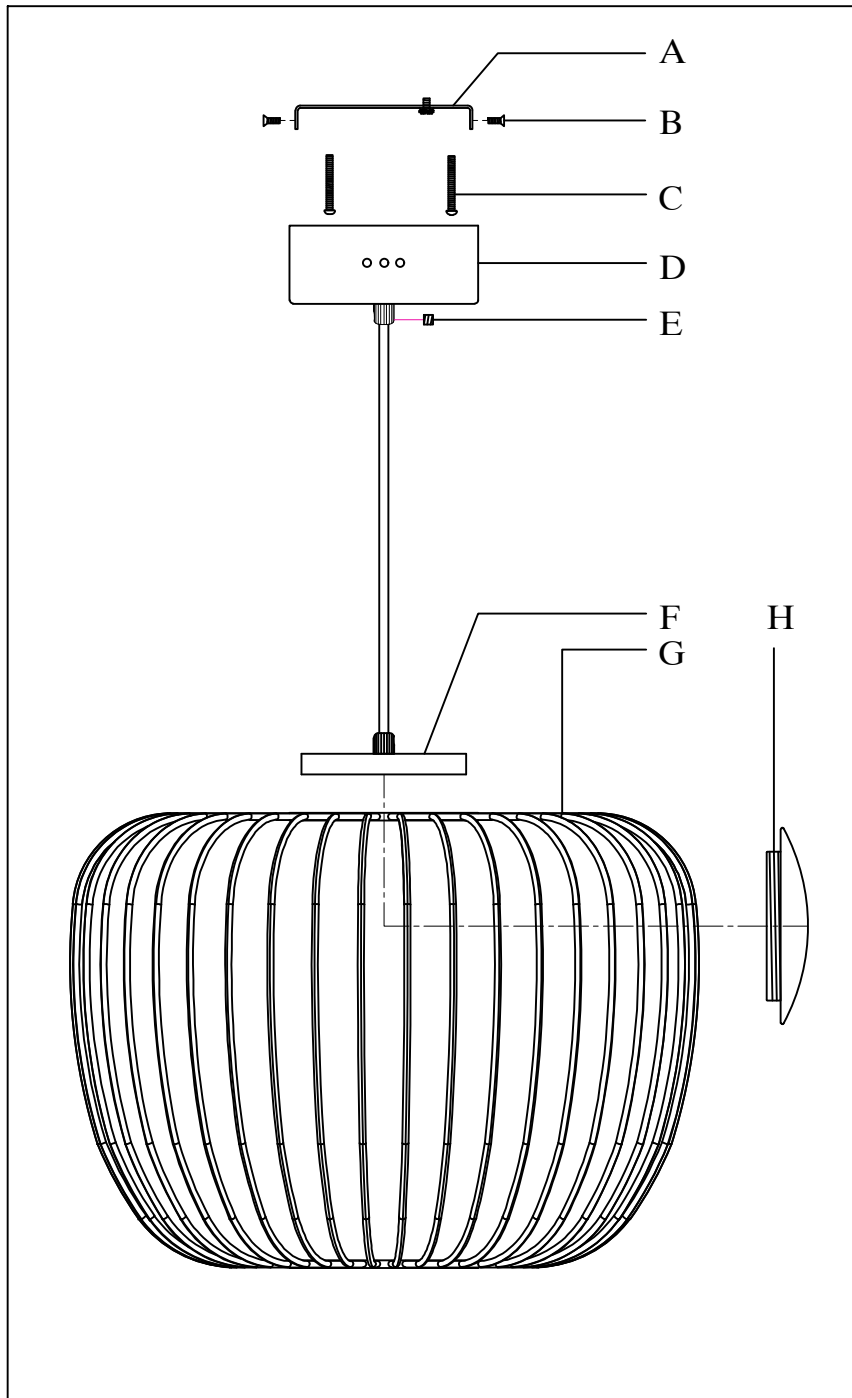

1.)

Step1 :Remove mounting bracket from fixture and install to electrical box.

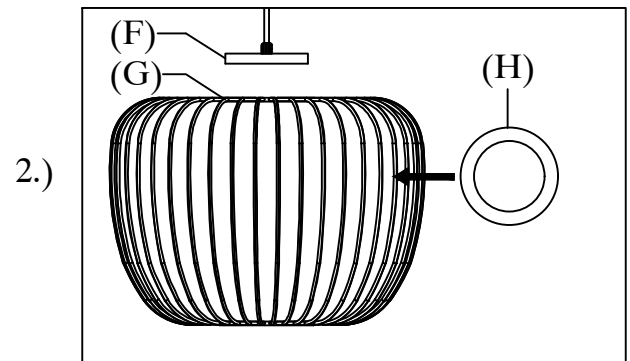

2.)

Step2 :Place the acrylic from the side of the lampshade.

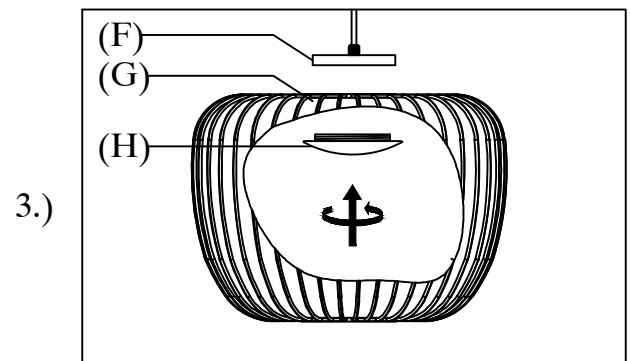

3.)

Step3 :Install acrylic into socket.

Cleaning & Care:

Clean with soft cloth and a mild detergent.
Do not use abrasive cleaner.

IMPORTANT: Turn off the power at the main fuse or circuit breaker box before starting installation

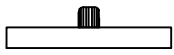

Socket(F)



lampshade(G)



Acrylic(H)



Plastic
Screws(E)

Locate all hardware & components before discarding packaging

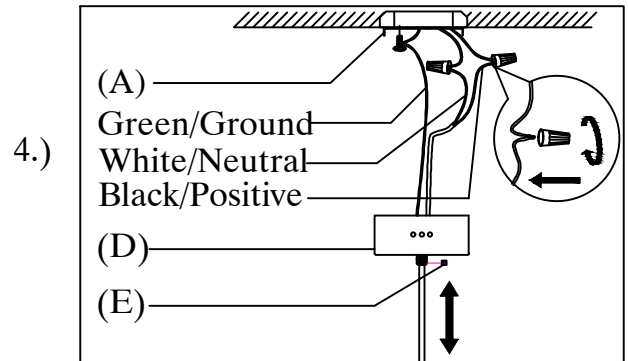
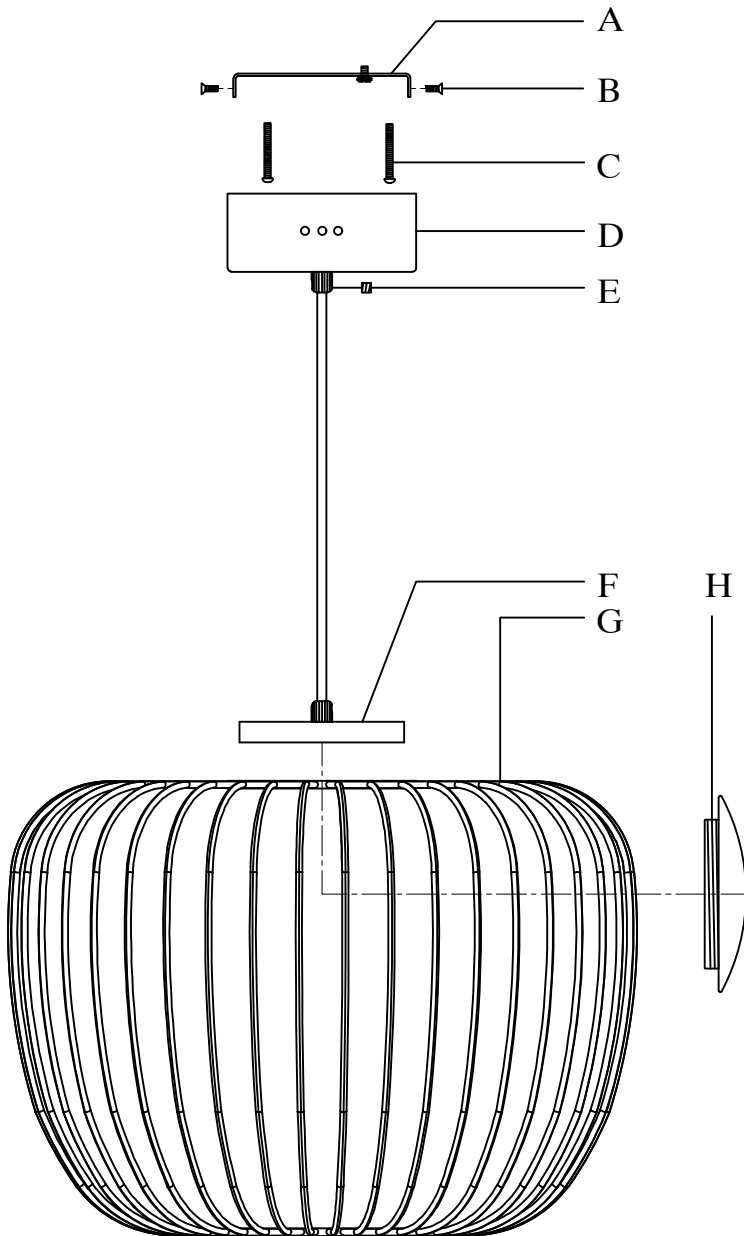

Step4 :Adjust wire length to desired mounting height, and tighten strain relief screws to secure. Wire fixture to wires in outlet box. Green wire is for Ground.

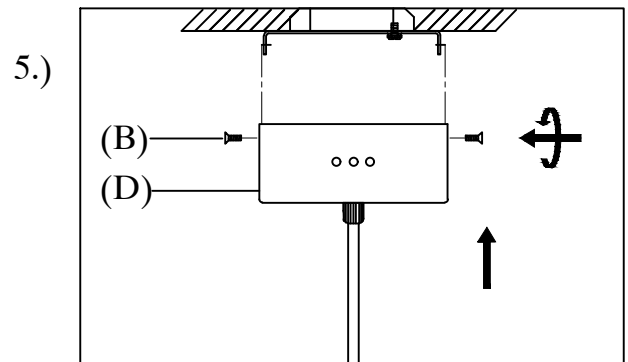

Step5 :Install fixture to bracket and Screws at the ends of the canopy to secure.

Cleaning & Care:

Clean with soft cloth and a mild detergent.
Do not use abrasive cleaner.