



Contemporary Lighting

PRODUCT NAME: Polka

ITEM NUMBER: E20773-18PC

Please consult your electrician for hanging fixture and wiring.

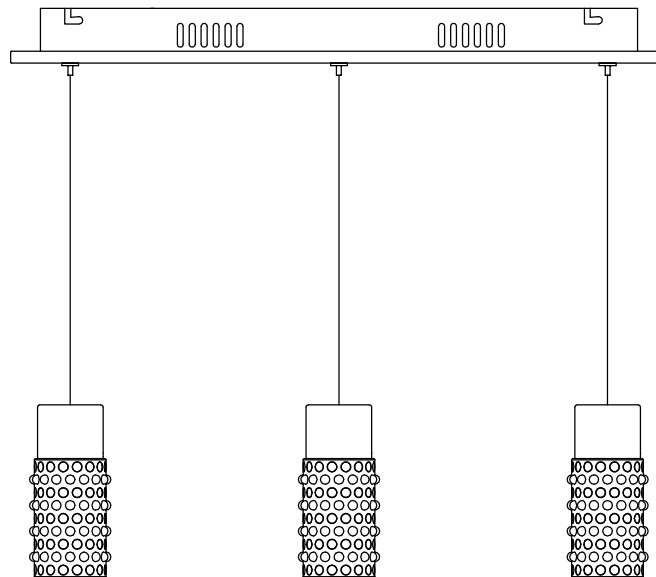

The fixture is designed to dim with a standard Triac forward phase dimmer. Dimming levels will vary by dimmer.

Below is a list of recommended dimmers:

- Lutron MACL-153M
- Lutron DVL-153P
- Lutron SCL-153P
- Leviton IPL06-10Z
- Leviton 6674-POW

Due to inrush current wattage should not exceed 150 watts of product for a 600 watt dimmer.

Warning! This fixture is supplied with an installed LED driver. These fixtures are dimmable using standard triac dimmer. For best operation we recommend using Lutron CL Dimmers.

IMPORTANT: Turn off the power at the main fuse or circuit breaker box before starting installation

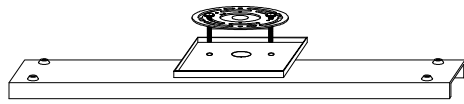

(A)
Mounting Bracket



(B)
Screw Nut



(C)
Anchors



(G)
Glass

Locate all hardware & components before discarding packaging

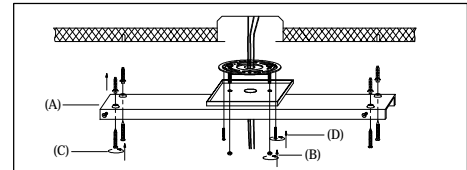
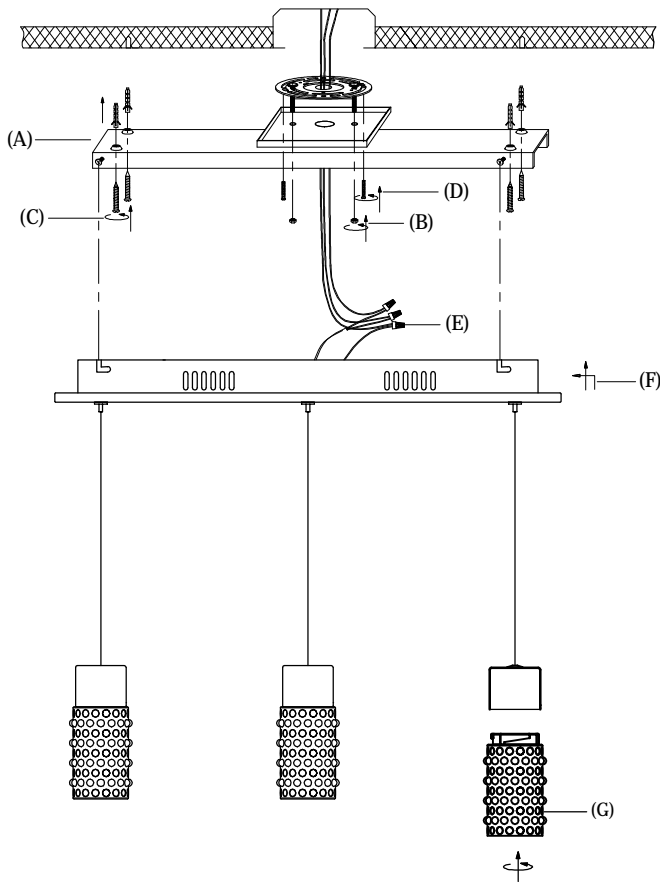

1.)

Step.1: Remove mounting bracket from fixture and install to electrical box using screws (D). Mark where screws at ends of bracket (A) meet the ceiling. Remove mounting bracket (A) from ceiling. Drill holes using 3/16" ± drill bit where marked. Install mounting bracket (A) to outlet box by attaching anchors (C) and screw nuts (B) to secure bracket at ends.

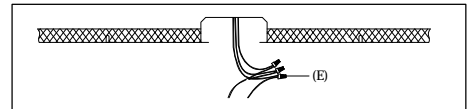

2.)

Step.2: Wire fixture to wires (E) in outlet box. Copper wire is for Ground.

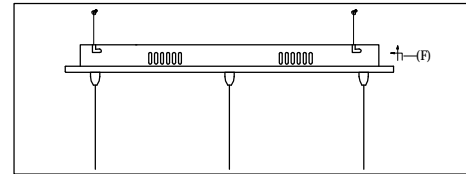

3.)

Step.3: Adjust wire length to desired mounting height, and tighten strain relief screws to secure. Install canopy to bracket and tighten screws (F) at the ends of the canopy to secure.

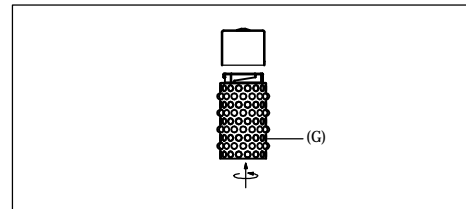

4.)

Step.4: Screw glass (G) into place to secure.

Cleaning & Care:

Clean with soft cloth and a mild detergent.
Do not use abrasive cleaner.