



Contemporary
Lighting™

PRODUCT NAME: Pyramid LED Pendant

ITEM NUMBER: E20815

Please consult your electrician for hanging fixture and wiring.

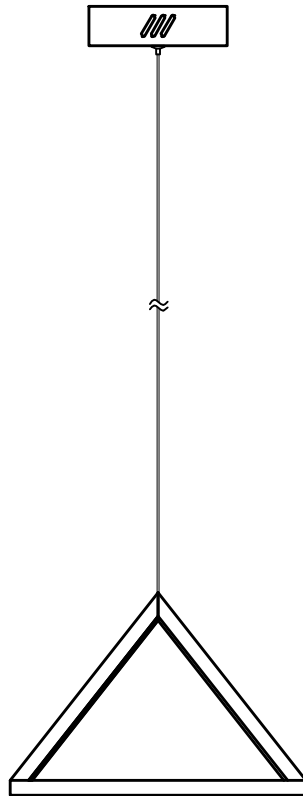

WARNING: Wires need to be connected to driver found in canopy and should not be connected directly to power source or a short may occur.

The fixture is designed to dim with a standard Triac forward phase dimmer.

Dimming levels will vary by dimmer.

Below is a list of recommended dimmers:

Lutron MACL-153M

Lutron DVL-153P

Lutron SCL-153P

Leviton IPL06-10Z

Leviton 6674-POW

Due to inrush current wattage should not exceed 150 watts of product for a 600 watt dimmer.

LED 20W

IMPORTANT: Turn off the power at the main fuse or circuit breaker box before starting installation



Screws*2PCS



Bracket



Mounting Screws*2PCS

Locate all hardware & components before discarding packaging

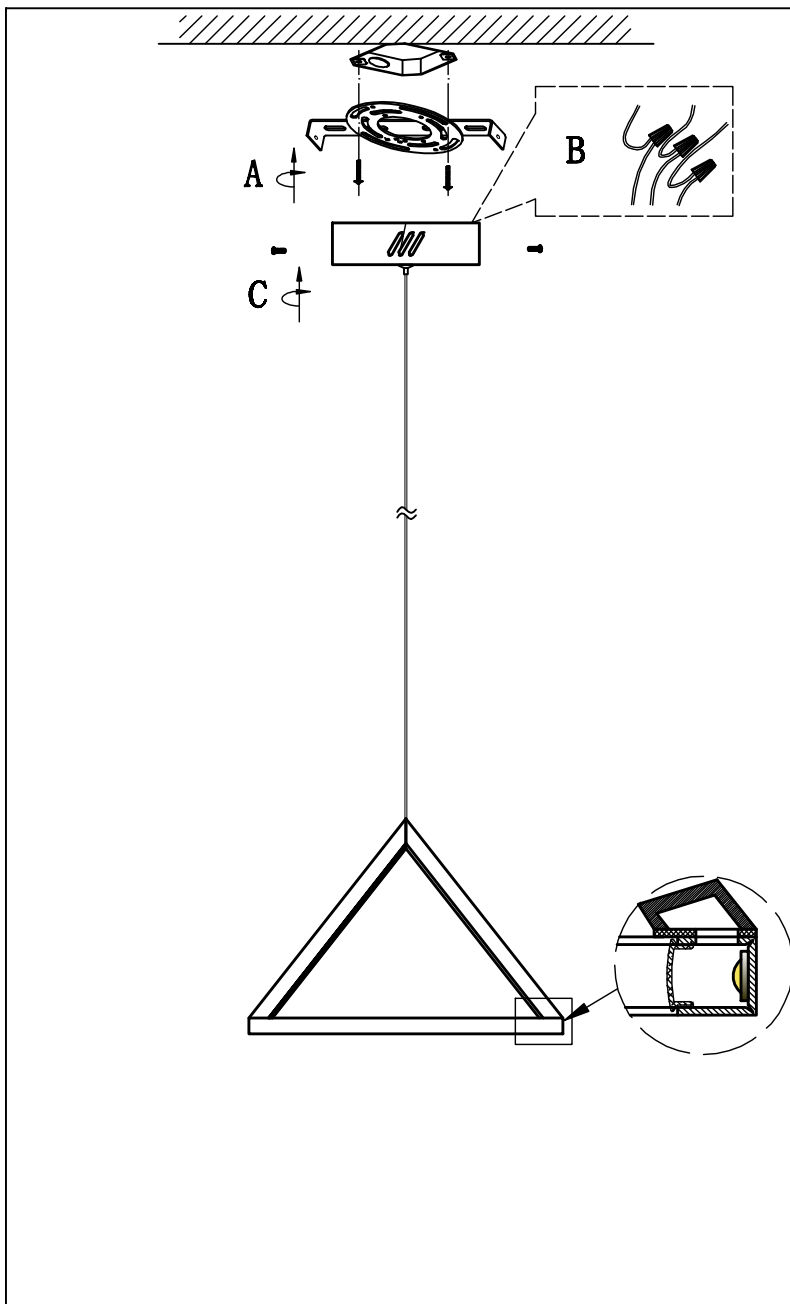

1.)

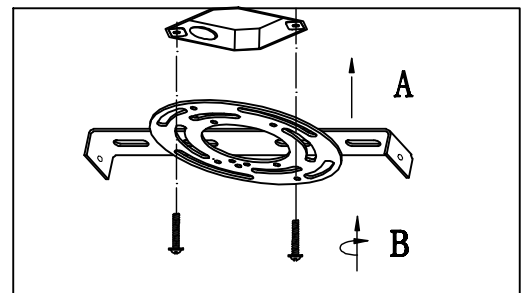

Step 1: Remove mounting bracket from fixture and install to electrical box.

2.)

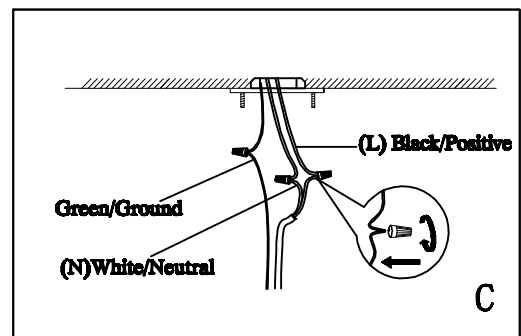

Step 2: Wire fixtures to wire in outlet box. Refer to dual plastic wire instructions to connect low voltage wire to driver. Wires must be connected to driver located in canopy or a short may occur.

Cleaning & Care:

Clean with soft cloth and a mild detergent.

Do not use abrasive cleaner.

Dual Plastic Wiring Instructions

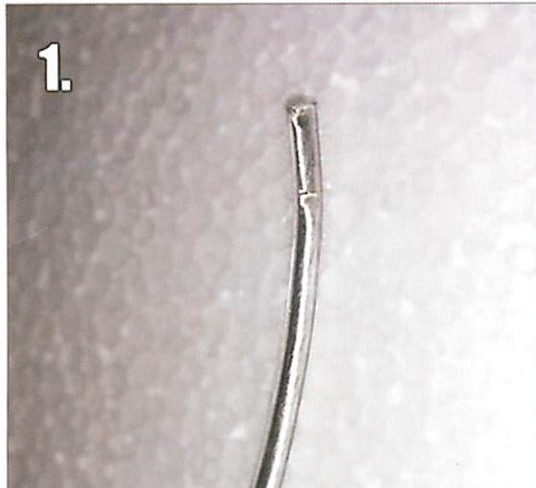

Strip the clear plastic off the pendant electrical wire.



Exposed is the mesh wire and the inner wire.

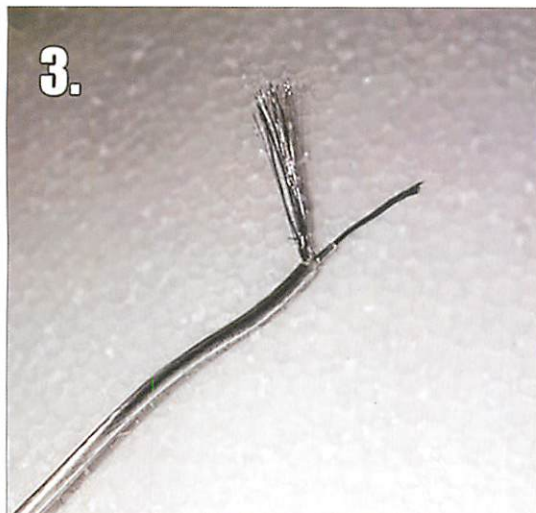

Pull the mesh wire away to isolate the inner wire. The inner wire will also have a plastic coat that needs to be stripped.

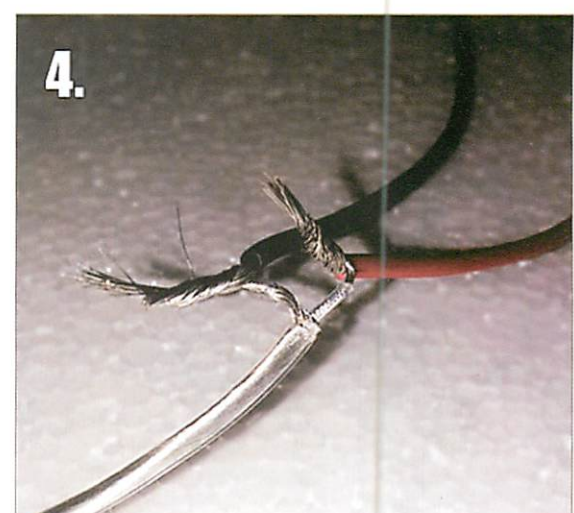

Once the two wires are formed, connect the mesh wire (ground) to the black wire and the inner wire to the red wire (live).