

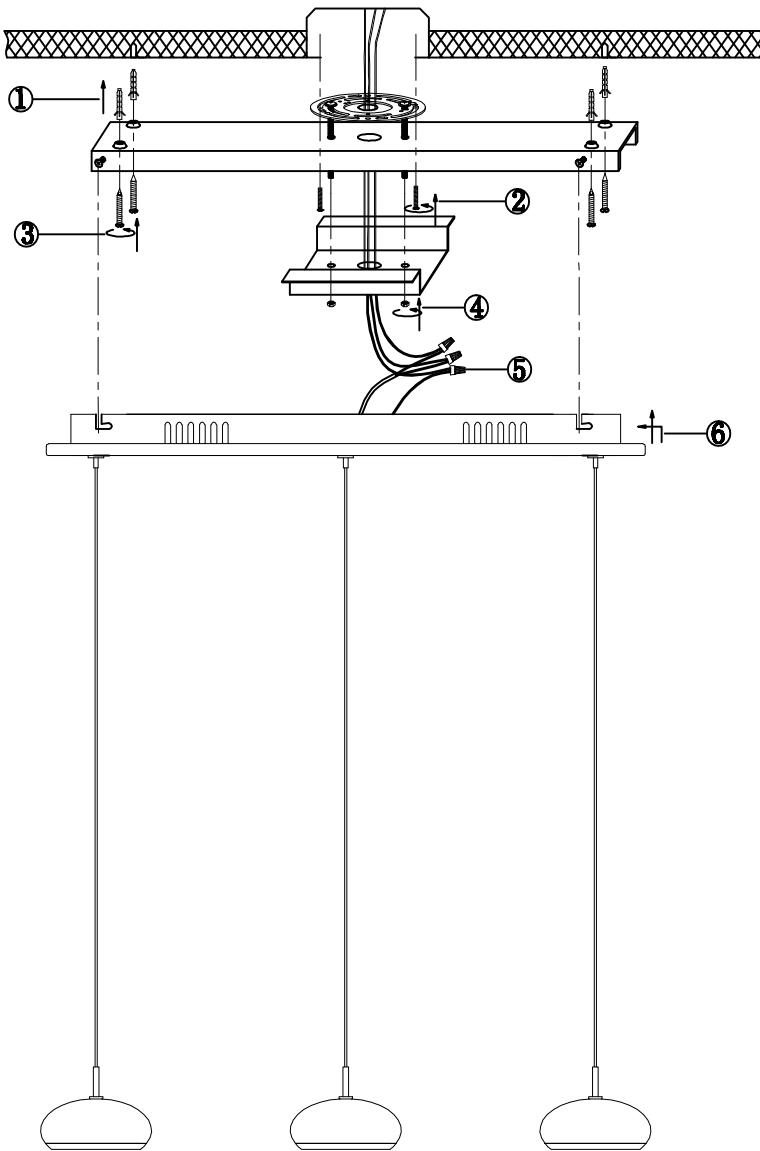

Installation Instructions Model E22253-PC



1. It is recommended the fixture be installed by a qualified licensed electrician.
2. Turn breaker off for circuit on outlet where fixture is to be installed.
3. Install round mounting bracket to outlet box.
4. Determine mounting height of fixture and adjust wires accordingly.
5. Position linear mounting bracket onto mounting plate and mark 4 hole for anchors.
6. Drill 4 x 1/8" holes and insert hallow wall anchors.
7. Install liner mounting to ceiling using screws for anchors.
8. Install trim plate onto screws protruding through mounting plate and secure with nuts supplied.
9. Wire fixture to outlet. Connect white to neutral and green to ground.
10. Install fixture onto linear mounting bracket and tighten screws to secure.

Warning! This fixture is supplied with permanently installed LED light engine. The transformer for this light engine is not dimmable. Do not use a dimmer on this fixture or it will damage the transformer. Using a dimmer voids the warranty of the fixture.