

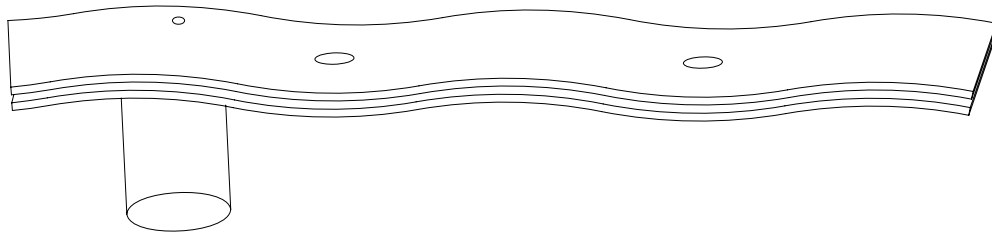

PRODUCT NAME : Roller LED Wall Sconce  
ITEM NUMBER: E22820-MW

Please consult your electrician for hanging fixture and wiring.



**WARNING: WIRES NEED TO BE CONNECTED TO DRIVER FOUND IN CANOPY AND SHOULD NOT CONECT DIRECTLY TO POWER SOURCE OR A SHORT MIGHT OCCUR.**

The fixture is designed to dim with a standard Triac forward phase dimmer. Dimming levels will vary by dimmer.

Below is a list of recommended dimmers:

Lutron MACL-153M  
Lutron DVL-153P  
Lutron SCL-153P  
Leviton IPL06-10Z  
Leviton 6674-POW

**Due to the inrush current wattage should not exceed 150 watts of product for a 600 watt dimmer.**

4x5W LED

**IMPORTANT:** Turn off the power at the main fuse or circuit breaker box before starting installation

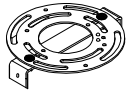

(A)  
Mounting Bracket

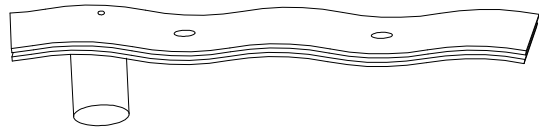

(B)  
Canopy

Locate all hardware & components before discarding packaging

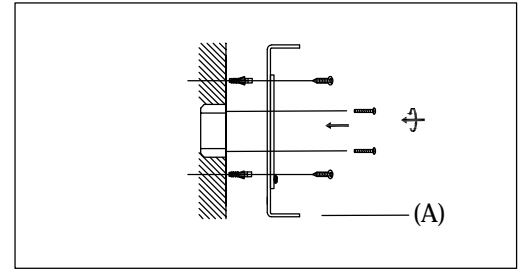
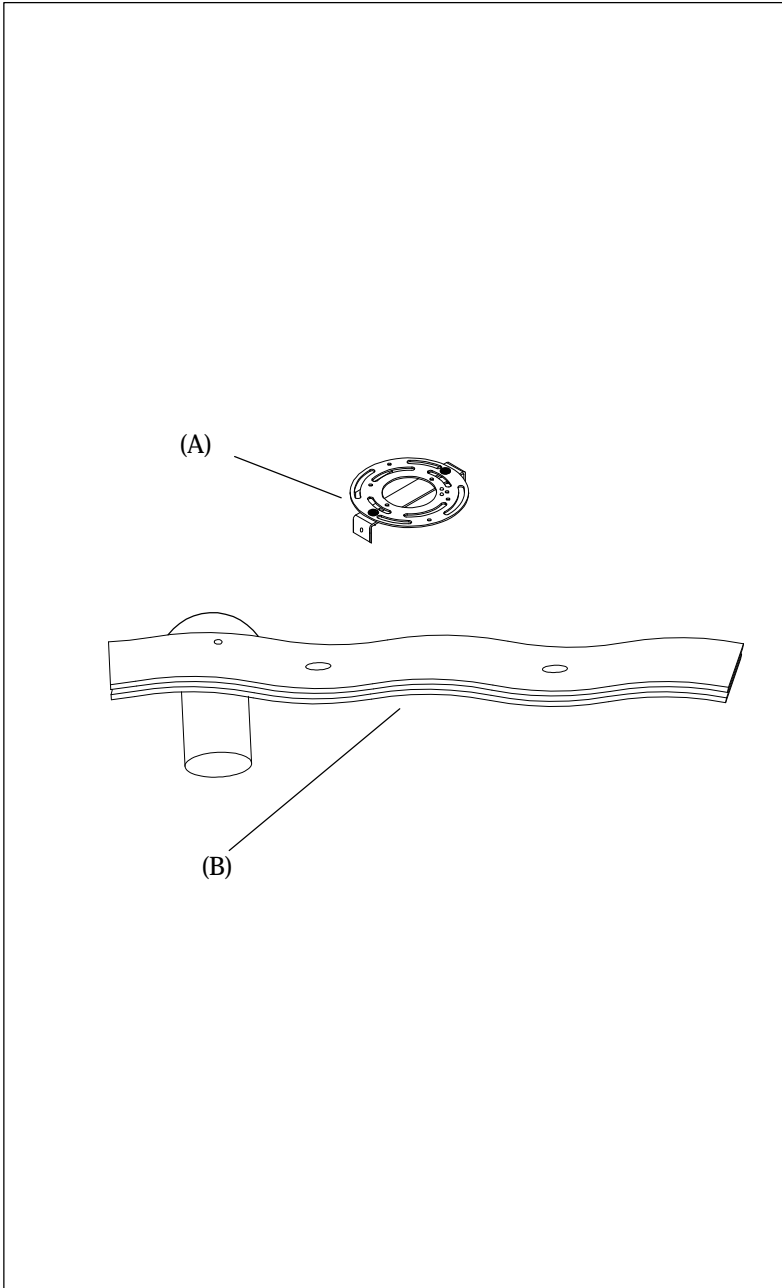

1.)

**Step.1:** Remove Bracket (A) from fixture and install to electrical box.

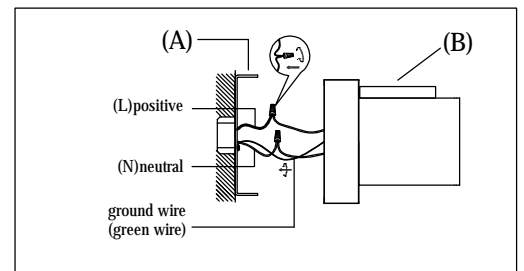

2.)

**Step.2:** Wire fixture to wires in outlet box.  
Install Green wire to Ground Screw.

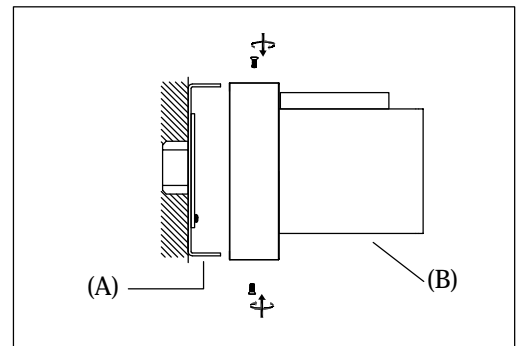

3.)

**Step.3:** Install Body (B) to Canopy (A) and tighten screws at the ends of the canopy to secure.

**Cleaning & Care:**  
Clean with soft cloth and a mild detergent.  
Do not use abrasive cleaner.