

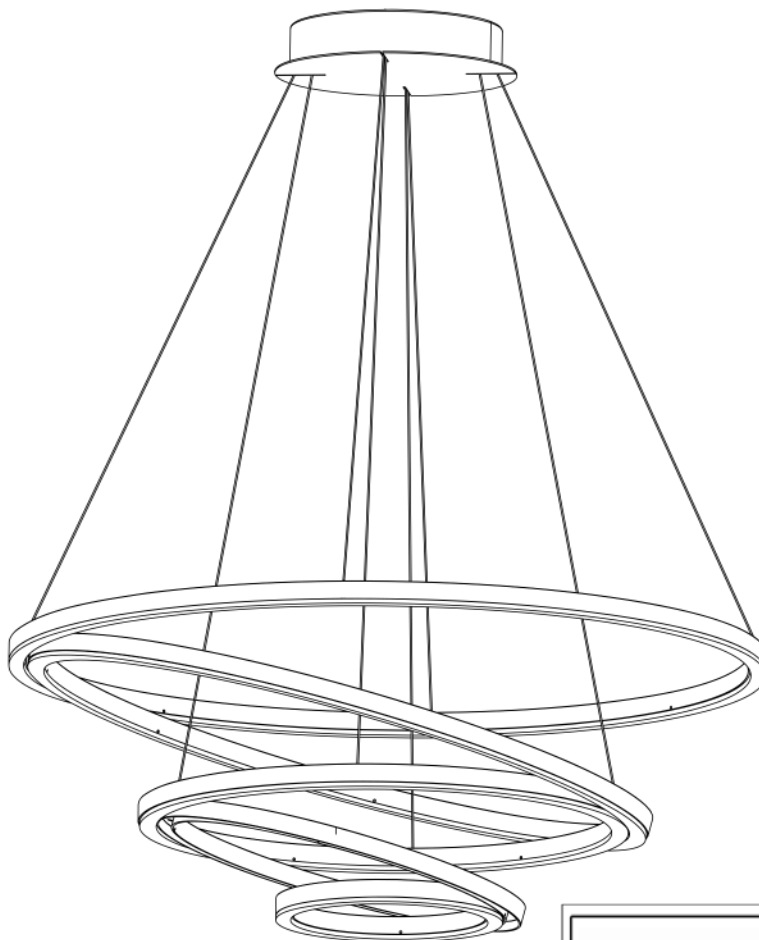

Contemporary
Lighting™

PRODUCT NAME : Cirque LED Pendant
ITEM NUMBER: E22849-MW

Please consult your electrician for hanging fixture and wiring.



WARNING: WIRES NEED TO BE CONNECTED TO DRIVER FOUND IN CANOPY AND SHOULD NOT CONECT DIRECTLY TO POWER SOURCE OR A SHORT MIGHT OCCUR.

This fixture is designed to dim with an Electronic Low Voltage dimmer. Dimming levels will vary by dimmer.

Below is a List of Recommended Dimmers:

- Lutron DVELV-330P
- Leviton IPL06-10Z
- Legrand Tru-Universal ADTP703TUW4
- Lutron MAELV-600M
- Lutron SAELV-153P
- Leviton 6674-POW

Due to the inrush current wattage should not exceed 150 watts of product for a 600 watt dimmer.

195W LED

IMPORTANT: Turn off the power at the main fuse or circuit breaker box before starting installation

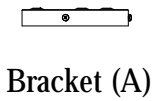

Bracket (A)

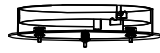

Canopy (B)

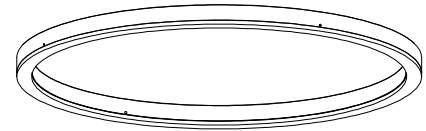

(C)
Body

Locate all hardware & components before discarding packaging

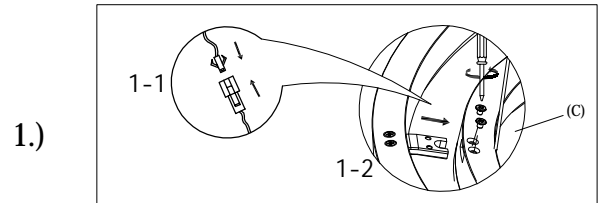
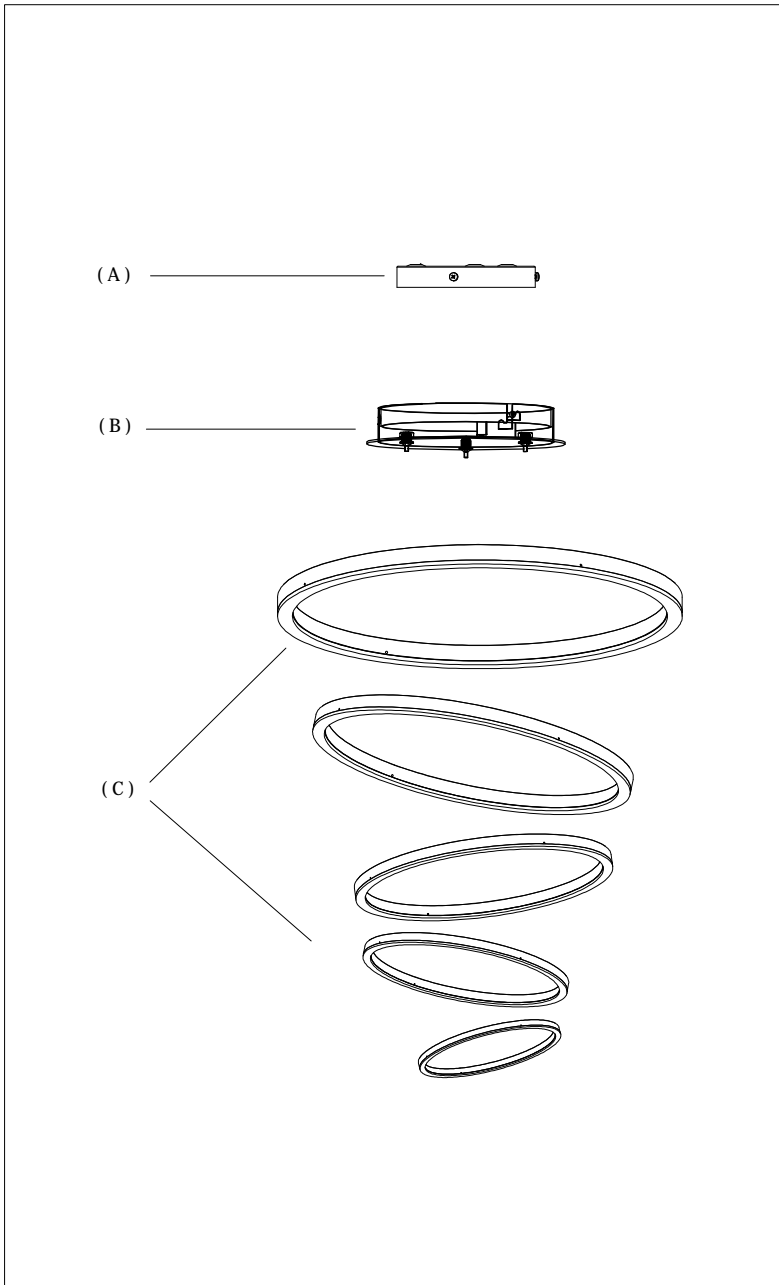

1.)

Step.1: First connect the lamp body (C) parts together by inserting male tab at opening and screw to secure.

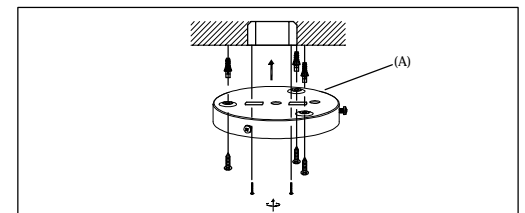

2.)

Step.2: Remove Bracket (A) from fixture and install to electrical box.

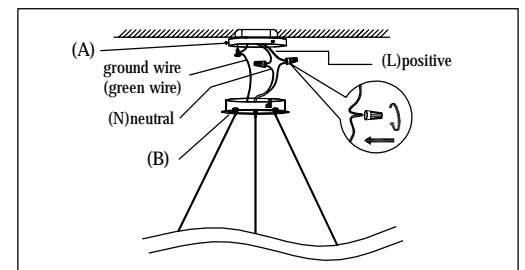

3.)

Step.3: Wire fixture to wires in outlet box. Install Green wire to Ground Screw.

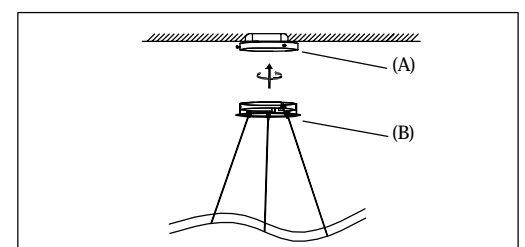

4.)

Step 4: Adjust wire length to desired hanging height. Install Canopy (B) to Bracket (A) and tighten screws at the ends of canopy to secure.

Cleaning & Care:
Clean with soft cloth and a mild detergent.
Do not use abrasive cleaner.

Cleaning & Care:
Clean with soft cloth and a mild detergent.
Do not use abrasive cleaner.