

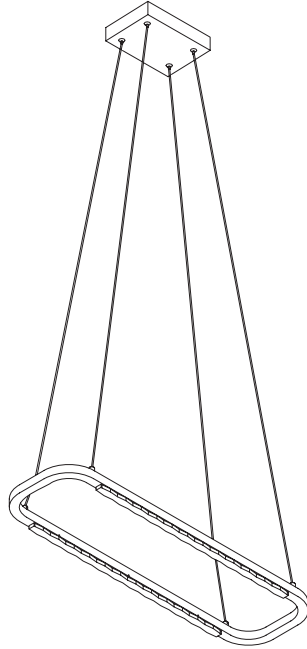

PRODUCT NAME : Jibe LED Pendant  
ITEM NUMBER: E23205-MW

Please consult your electrician for hanging fixture and wiring.



**WARNING: WIRES NEED TO BE CONNECTED TO DRIVER FOUND IN CANOPY AND SHOULD NOT CONNECT DIRECTLY TO POWER SOURCE OR A SHORT MIGHT OCCUR.**

The fixture is designed to dim with a standard Triac forward phase dimmer. Dimming levels will vary by dimmer.  
Below is a list of recommended dimmers:  
Lutron MACL-153M  
Lutron DVL-153P  
Lutron SCL-153P  
Leviton IPL06-10Z  
Leviton 6674-POW

Due to the inrush current wattage should not exceed 150 watts of product for a 600 watt dimmer.

39W LED

IMPORTANT: Turn off the power at the main fuse or circuit breaker box before starting installation

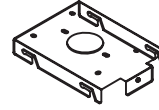

(A) Bracket



(B) Canopy

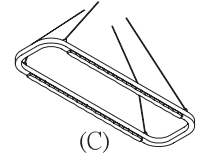

(C) Body

Locate all hardware & components before discarding packaging

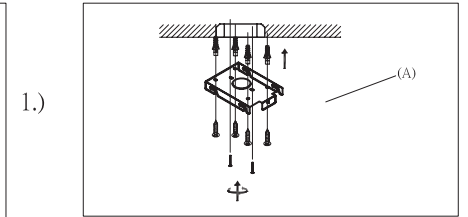
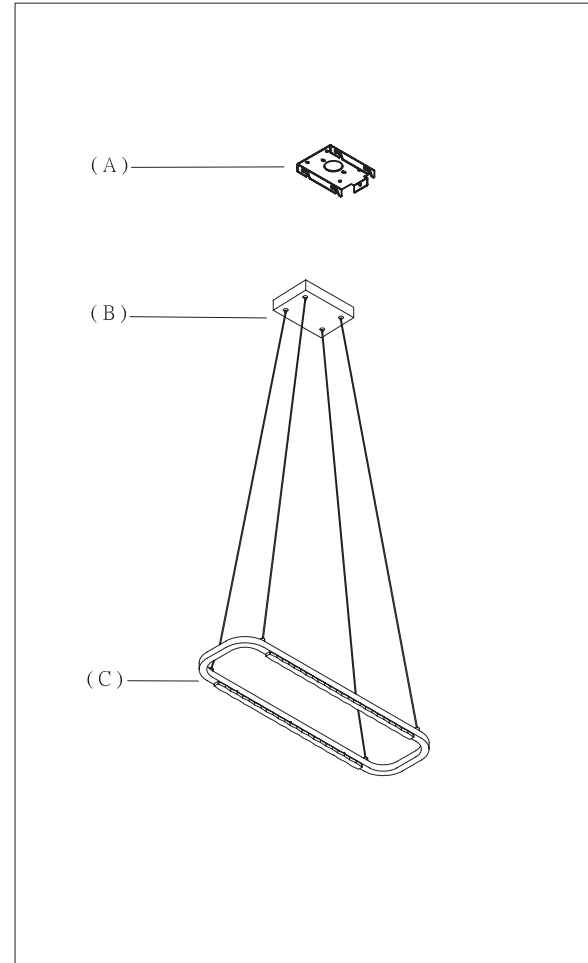

1.)

Step.1: Remove Bracket (A) from fixture and install to electrical box.

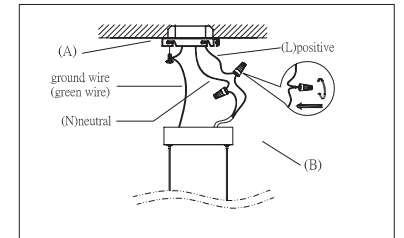

2.)

Step.2: Wire fixture to wires in outlet box. Install Green wire to Ground Screw.

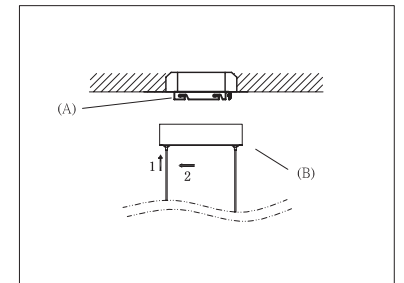

3.)

Step 3: Adjust wire length to desired hanging height. Will be Canopy (B) corresponding Bracket (A) card slot to right tight