

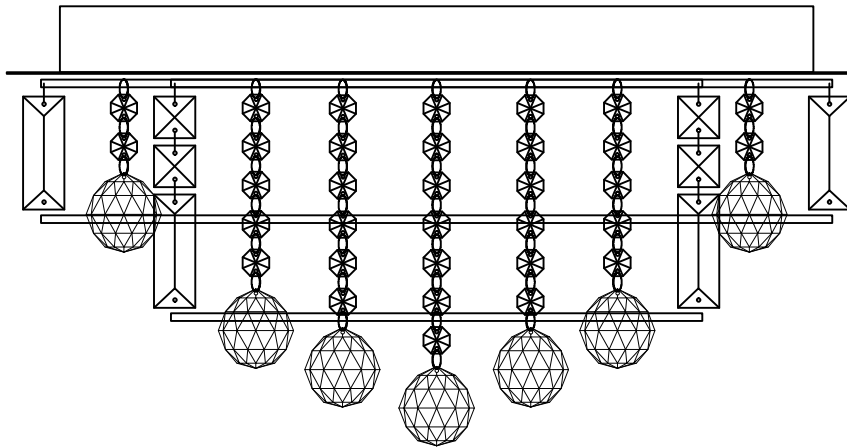

# Contemporary Lighting

PRODUCT NAME: BANGLE  
ITEM NUMBER: E23257-20PC

Please consult your electrician for hanging fixture and wiring.



**Caution: Xenon bulbs get very hot and may burn you. Always make sure bulbs are off for a minimum of 10 minutes before handling. Fixture may be dimmed using an electronic low voltage dimmer.**

**Bulbs (Included): 12 x 25 Watt G9**

**IMPORTANT:** Turn off the power at the main fuse or circuit breaker box before starting installation

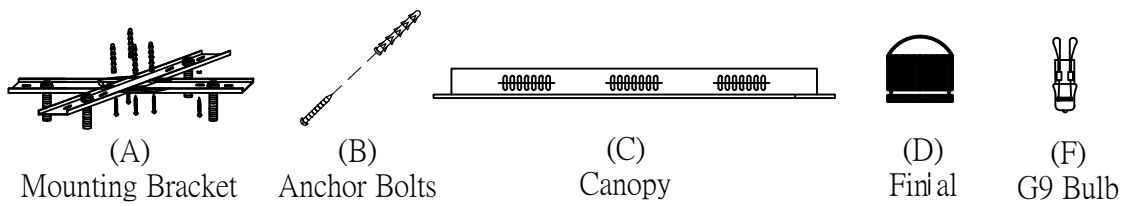

Locate all hardware & components before discarding packaging

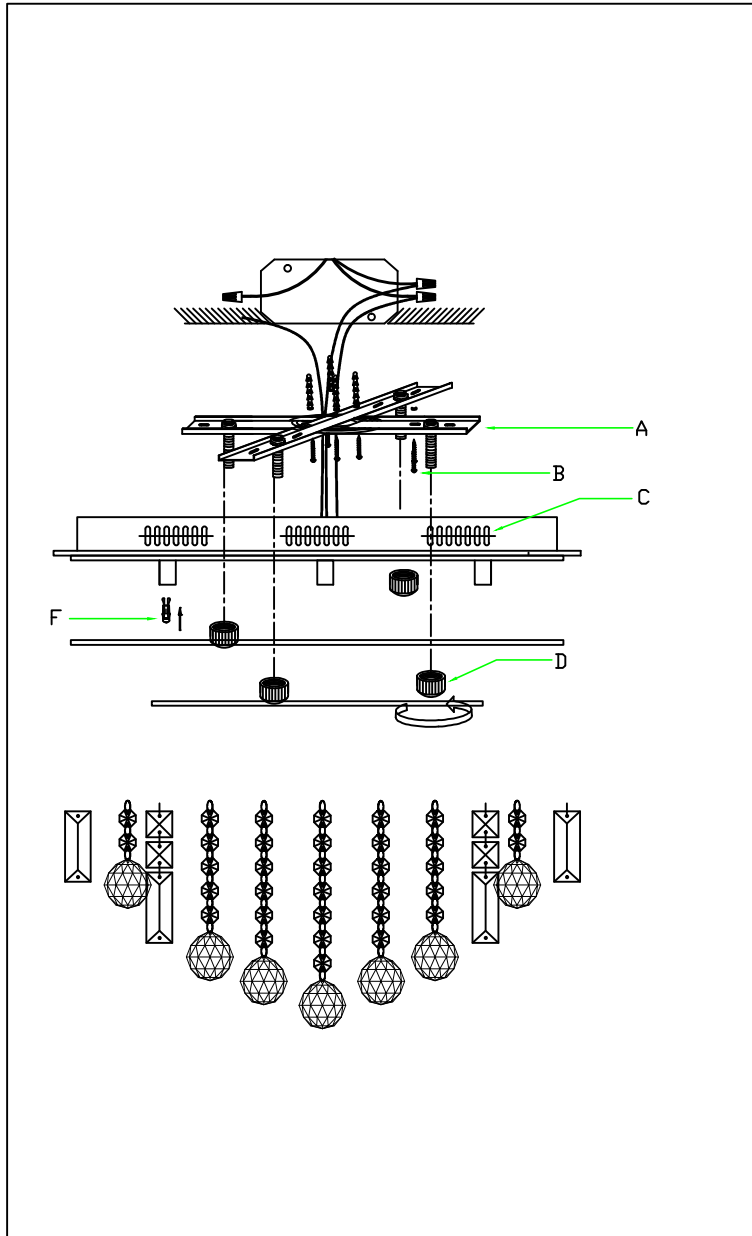

**Cleaning & Care:**

Clean with soft cloth and a mild detergent.  
Do not use abrasive cleaner.

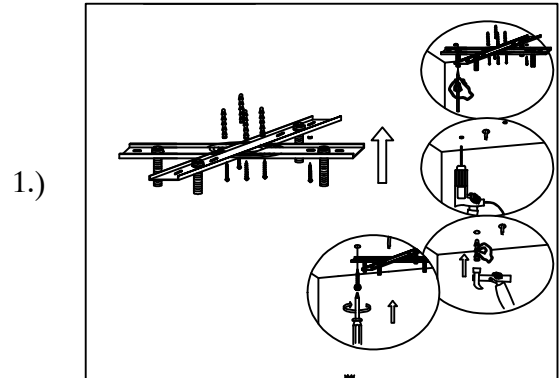

1.) Step.1: Remove mounting bracket (A) from Canopy (C) to install to electrical box

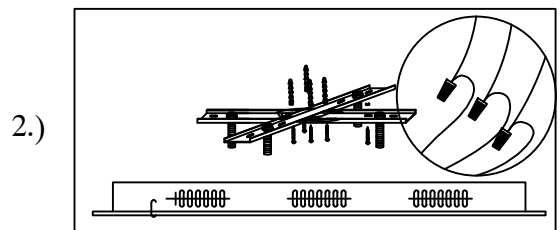

2.) Step.2: Wire fixture to wires in outlet box. Green wire is for Ground.

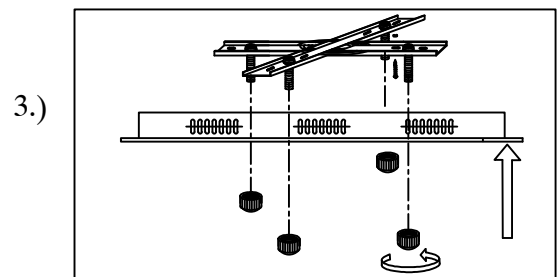

3.) Step.3: Screw finials (D) onto mounting bracket (A) until canopy is flush with ceiling.

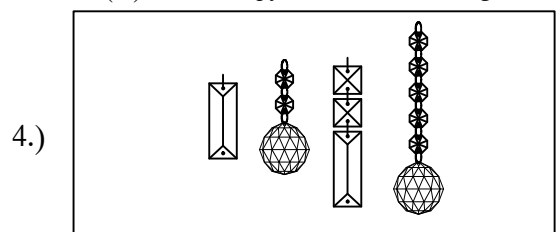



4.) Step.4: Hang Crystal According to Diagram on the next page.



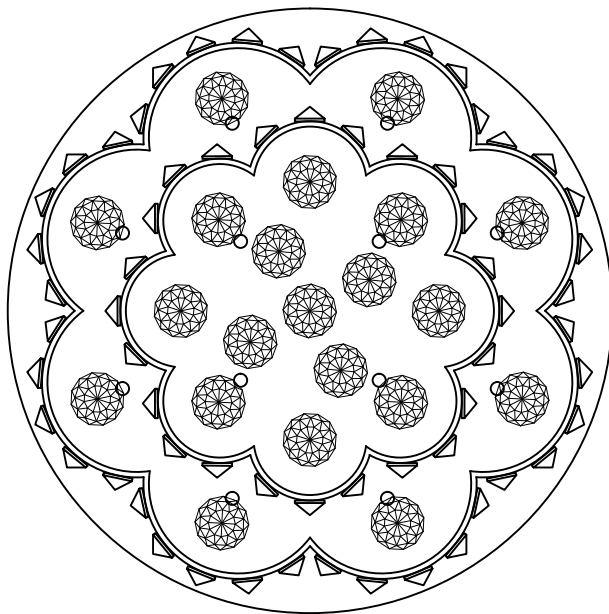
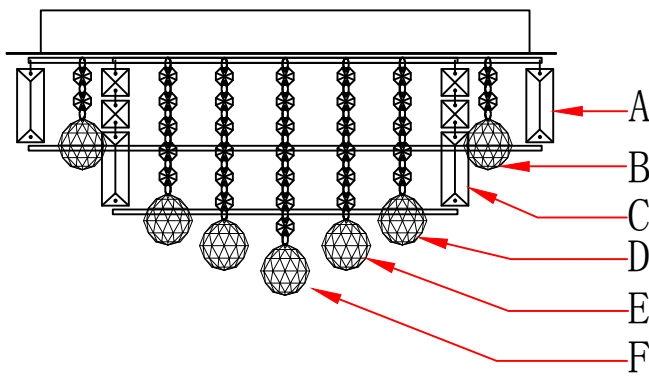

Contemporary  
Lighting™

## Model E23257-20PC Crystal Diagram





 A-40 (L:2.7")  
ECRY23257-SB1

 B-8 (L:3.6")  
ECRY23257-SB2

 C-24 (L:4.9")  
ECRY23257-SB3

 D-8 (L:5.5")  
ECRY23257-SB4

 E-4 (L:6.55")  
ECRY23257-SB5

 F-1 (L:7.32")  
ECRY23257-SA4