

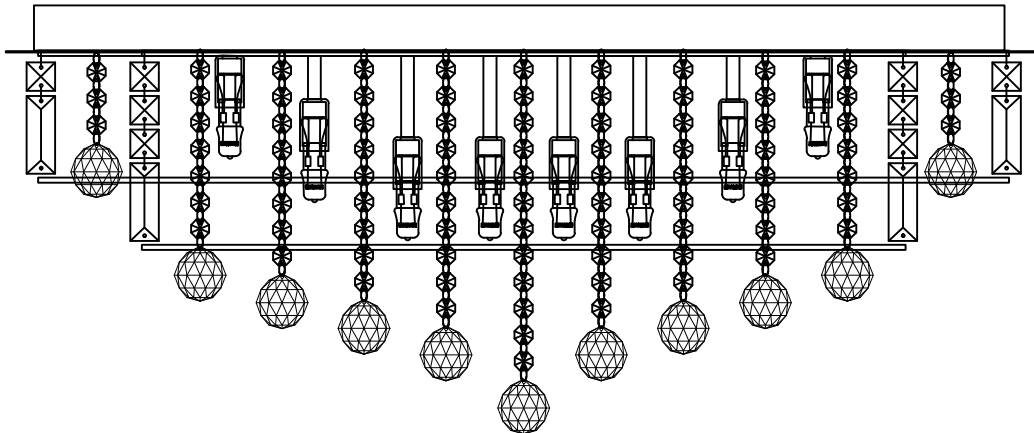

# Contemporary Lighting

PRODUCT NAME: BANGLE  
ITEM NUMBER: E23259-20PC

Please consult your electrician for hanging fixture and wiring.



Caution: Xenon bulbs get very hot and may burn you. Always make sure bulbs are off for a minimum of 10 minutes before handling. Fixture may be dimmed using an electronic low voltage dimmer.

Bulbs (Included): 28 x 25 Watt G9

**IMPORTANT:** Turn off the power at the main fuse or circuit breaker box before starting installation

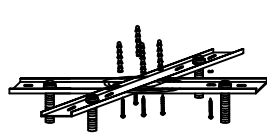

(A)  
Mounting Bracket



(B)  
Anchor Bolts

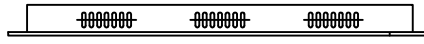

(C)  
Canopy



(D)  
Finial



(F)  
G9 Bulb

Locate all hardware & components before discarding packaging

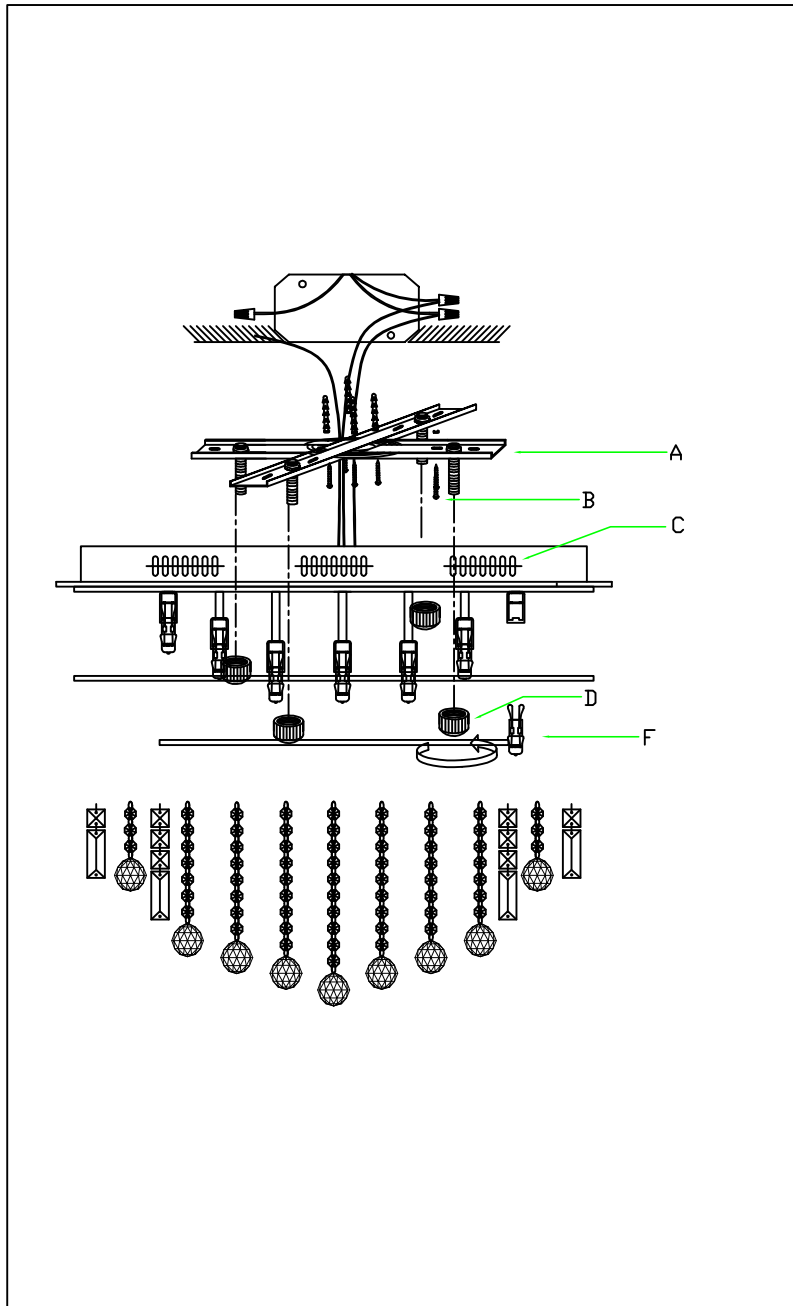

**Cleaning & Care:**

Clean with soft cloth and a mild detergent.  
Do not use abrasive cleaner

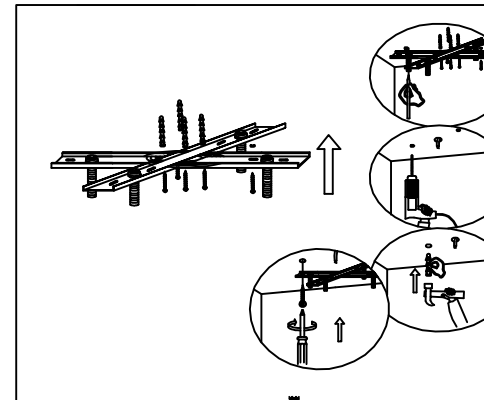

1.)

**Step.1:** Remove mounting bracket (A) from Canopy (C) to install to electrical box

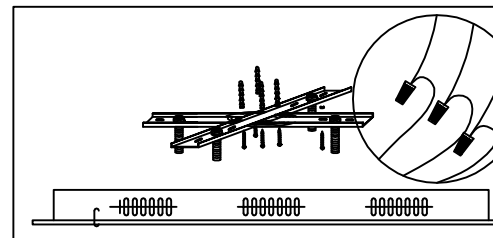

2.)

**Step.2:** Wire fixture to wires in outlet box. Green wire is for Ground.

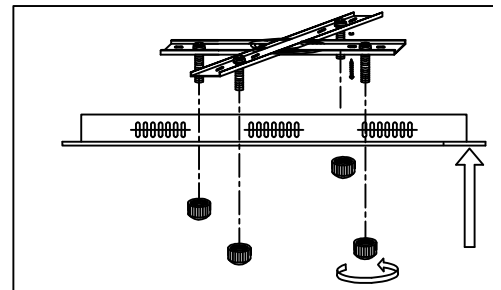

3.)

**Step.3:** Screw finials (D) onto mounting bracket (A) until canopy is flush with ceiling.

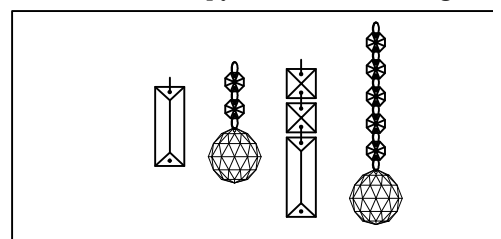

4.)







**Step.4:** Install G9 bulbs (F) and hang Crystal According to Diagram on the next page.

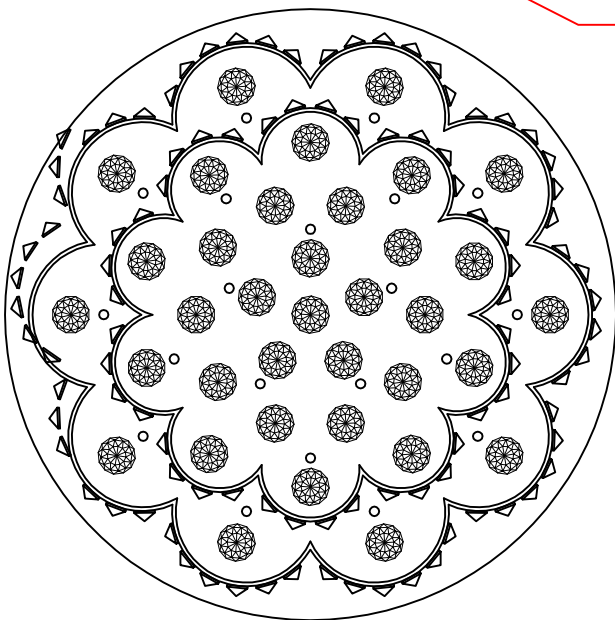
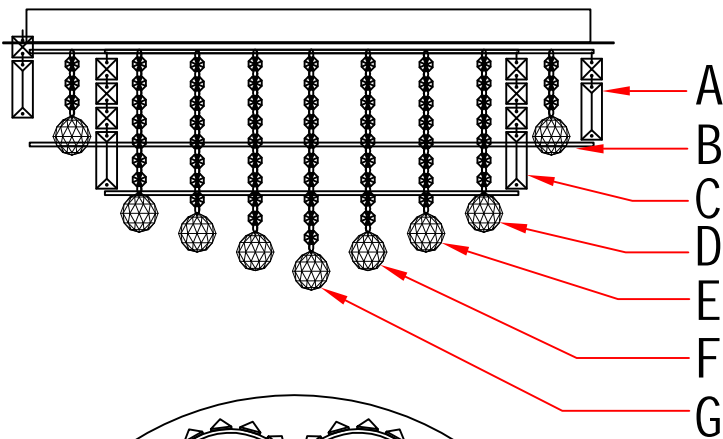

# Contemporary Lighting

## Model E23258-20PC Crystal Diagram



-  A-60 (L: 3.82")  
ECRY23259-SA1
-  B-10(L: 4.17")  
ECRY23259-SA2
-  C-40(L: 6.02")  
ECRY23259-SA3
-  D-10(L: 7.32")  
ECRY23259-SA4
-  E-10(L: 8.11")  
ECRY23259-SA5
-  F-5(L: 8.9")  
ECRY23259-SA6
-  G-1(L: 9.7")  
ECRY23259-SA7