

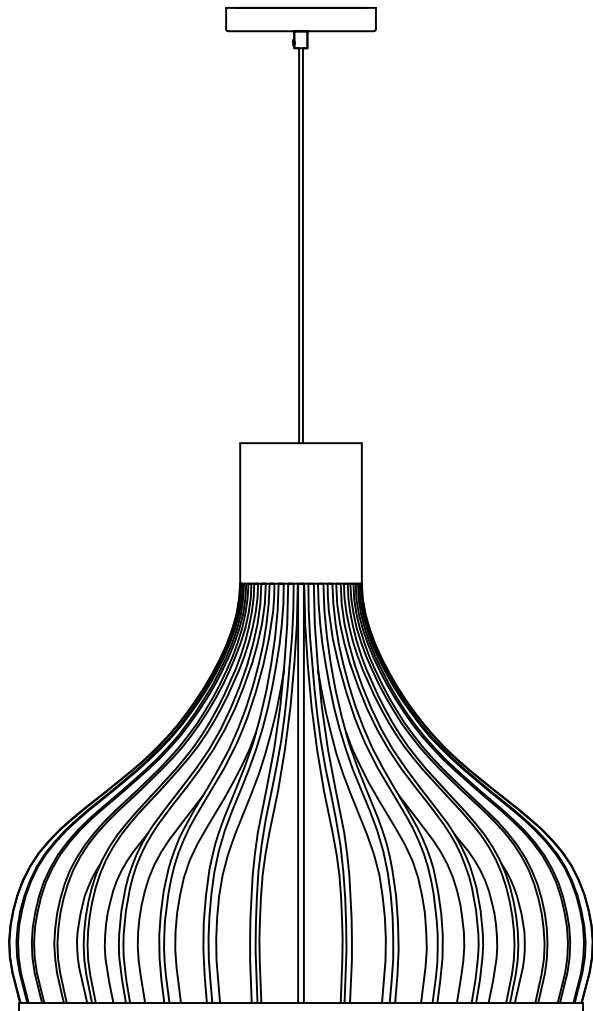

Contemporary Lighting

PRODUCT NAME: Turbo LED Pendant
ITEM NUMBER: E24568-75PC

Please consult your electrician for hanging fixture and wiring.



The fixture is designed to dim with a standard Triac forward phase dimmer. Dimming levels will vary by dimmer. Below is a list of recommended dimmers:

- Lutron MACL-153M
- Lutron DVL-153P
- Lutron SCL-153P
- Leviton IPL06-10Z
- Leviton 6674-POW

Due to the inrush current wattage should not exceed 150 watts of product for a 600 watt dimmer.

WARNING! Wires need to be connected to driver found in the canopy and should not be connected directly to the power source or a short may occur.

1 x LED Max. 20W

IMPORTANT: Turn OFF the power at the main fuse or circuit breaker box before starting installation

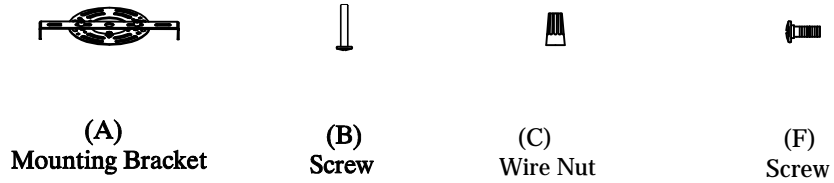

Locate all hardware & components before discarding packaging

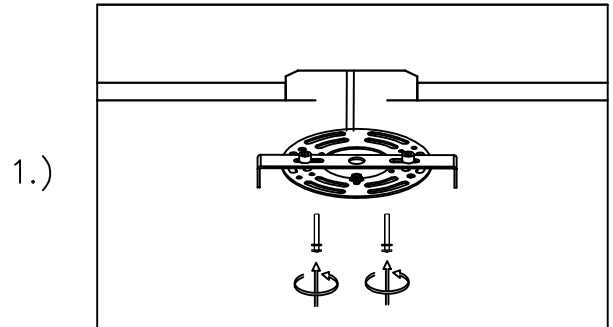
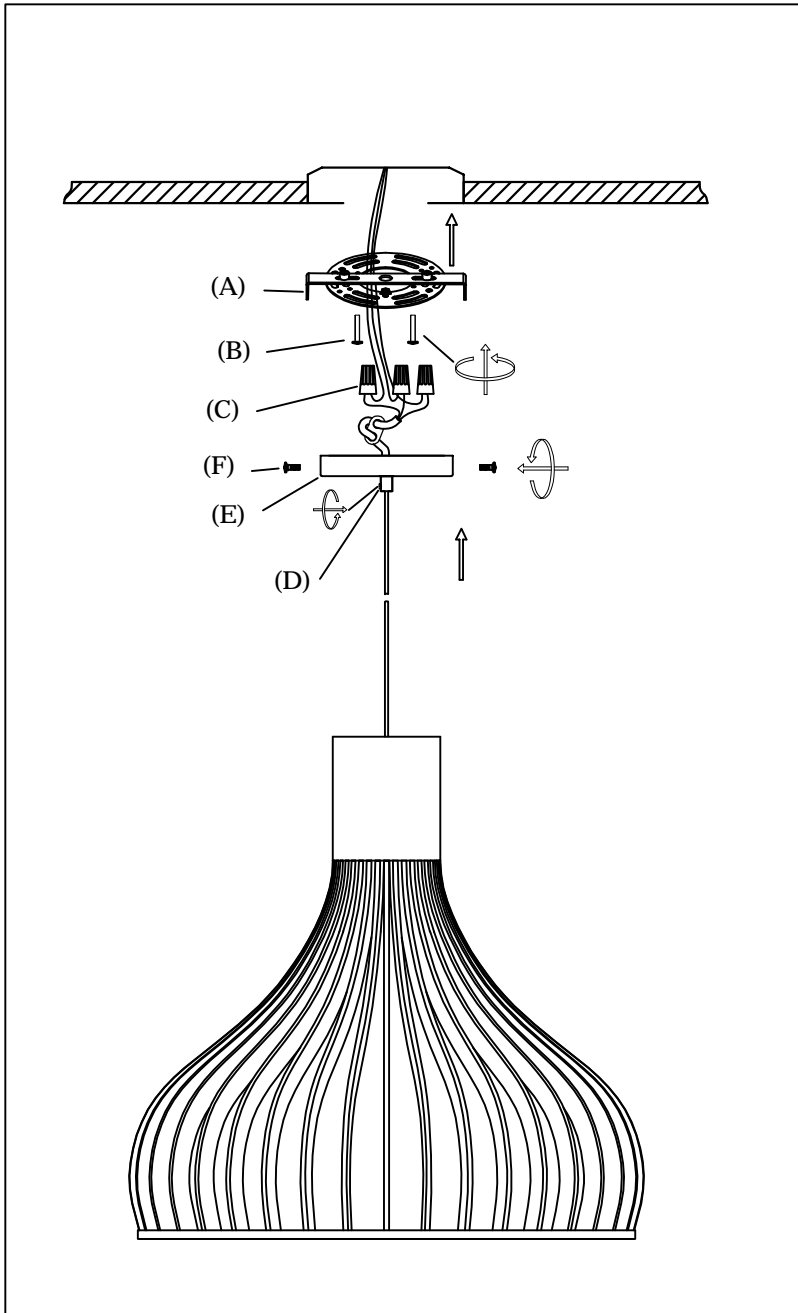

Step.1: Remove mounting bracket (A) from fixture and install to electrical box.

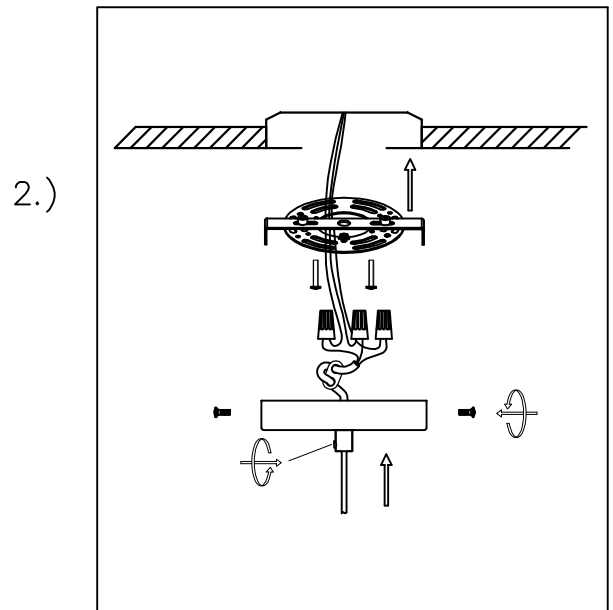

Step.2: Adjust wire length to desired mounting height, and tighten strain relief screw (D) to secure. Wire fixture to wires in outlet box. Green wire is for Ground. Install fixture to bracket and tighten screws (F) at the ends of the canopy (E) to secure.

Cleaning & Care:

Clean with soft cloth and a mild detergent.
Do not use abrasive cleaner.