

Contemporary Lighting

PRODUCT NAME: Alumilux

ITEM NUMBER: E41048-BZ / E41048-WT

Please consult your electrician for hanging fixture and wiring.

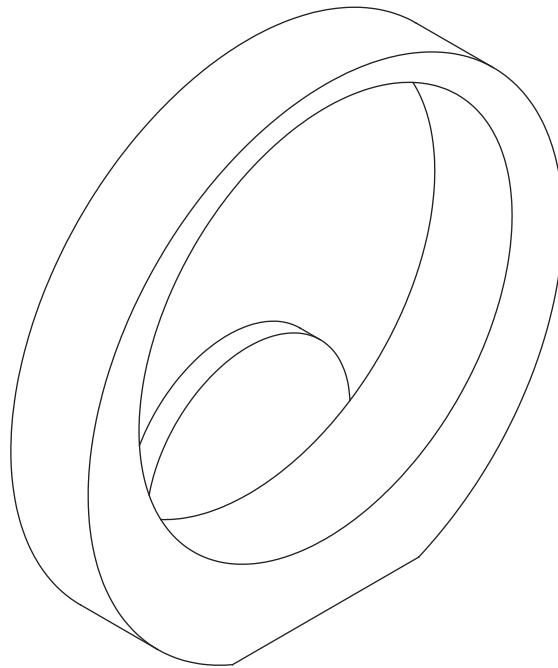

WARNING: Wires need to be connected to driver found in canopy and should not be connected directly to power source or a short may occur.

To prevent water intrusion, caulk around back-plate where fixture meets the wall using outdoor silicone sealant. Leave a small gap at the bottom to allow moisture to exit.

IMPORTANT: Turn off the power at the main fuse or circuit breaker box before starting installation



(A)

Mounting bracket

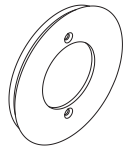

(B)

Backplate

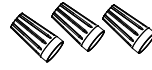

(C)

Wire Nuts (x3)



(D)

Mounting screws (x2)

Locate all hardware & components before discarding packaging

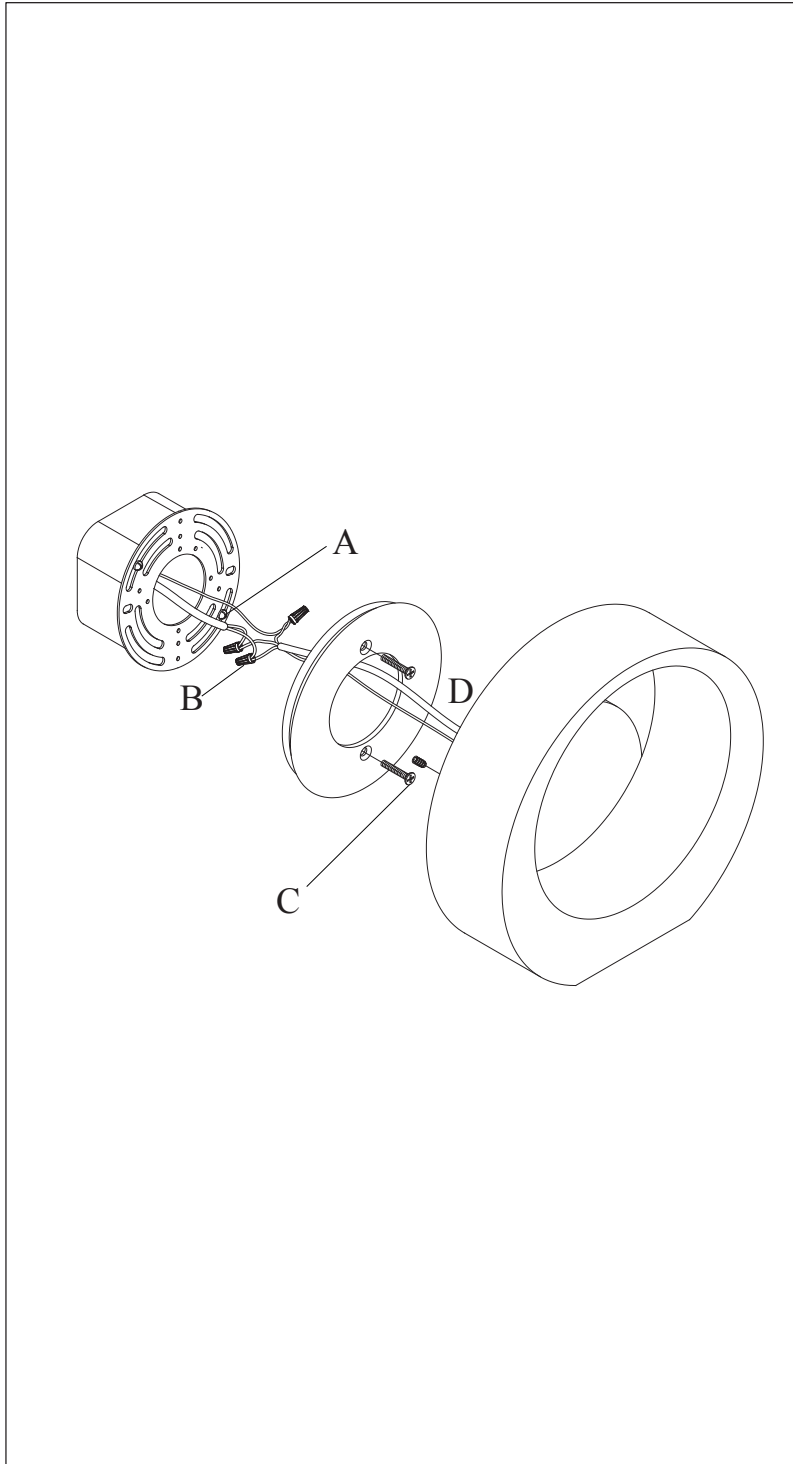

1.)

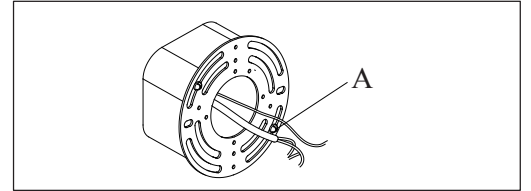

Step.1: Install Mounting bracket(A) to outlet box.

2.)

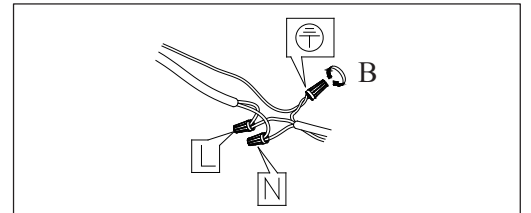

Step.2: Wire fixture to wires in outlet box.
Green/Copper wire is for Ground.

3.)

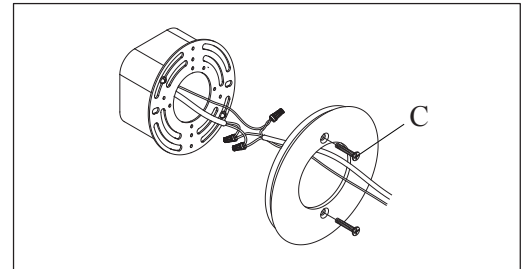

Step.3: Install Backplate(B) to Mounting bracket(A).

4.)

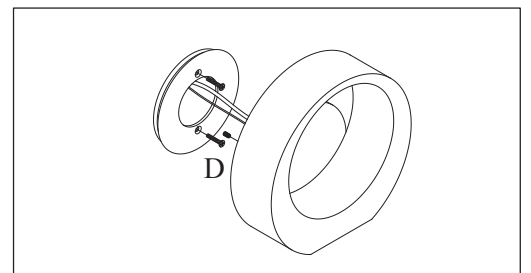

Step.4: Caulk around fixture with outdoor silicone sealant to prevent water intrusion. Leave a small gap at the bottom to allow moisture to escape. Install fixture to back plate (B) and tighten mounting screws (D) to secure.

Cleaning & Care:

Clean with soft cloth and a mild detergent.
Do not use abrasive cleaner.