



Model E41419-BZ

FOR USE ONLY WITH 12V LOW VOLTAGE LANDSCAPE POWER UNITS THAT DO NOT EXCEED 25 AMPS, 15 VOLT MAXIMUM.

WARNING: Luminaires must be installed in accordance with the National Electrical Code (NEC) and local codes. Failure to do so will void the warranty and may result in serious injury and/or damage to the luminaire.

LUMINAIRES ARE NOT TO BE INSTALLED WITHIN 10 FT. (3.05M) OF A POOL OR SPA. SECONDARY CABLE IS NOT TO BE BURIED MORE THAN 6". WHEN USING MULTIPLE LUMINAIRES, LOAD IS NOT TO EXCEED THE TOTAL WATTS OF TRANSFORMER RATING. DO NOT USE EXTENSION CORDS ON POWER UNITS.

NOTE: Always use UL recognized wire connectors for connections.

NOTE: Alumilux pathway light is provided with a ground stake to facilitate an in-grade installation. However, for a permanent and secure installation a concrete footing support for bollard post is recommended.

Ground Stake Installation

1. To prevent electrical shock, disconnect transformer from electrical supply before installation or service.
2. Dig a hole approximately 3" diameter by 2" deep at selected location.
3. Remove mounting plate from bottom of luminaire
4. Attach ground stake to mounting plate with 2 screws supplied
5. Thread 18/2 direct burial wire through center of ground stake and out exit hole of stake.
6. Connect 18/2 pigtail to main power cable with connector supplied. Turn on power supply to test connection.
7. Push ground stake into ground so that mounting plate is level with ground.
8. Attach fixture to mounting plate with screws provided

Concrete Footing Installation

Installation requires conduit sleeve to allow 36" pigtail to exit through concrete footing.

1. To prevent electrical shock, disconnect transformer from electrical supply before installation or service.
2. Dig a hole approximately 12" diameter by 6" deep at selected location.
3. Install foundation anchors to mounting plate. Position conduit sleeve to be center hole in mounting plate.
4. Using standard masonry procedures, support bollard base in selected location making mounting plate remain above concrete grade.
5. Pour concrete making sure exit end of conduit sleeve reaches outside concrete.
6. Run wire pigtail through bottom sleeve and attach to main power supply cable

NOTE: Luminaires are supplied with 36" of 18-2 cable pigtail for secure connection to main supply cable. Wire is to be protected by routing in close proximity to luminaire. Wiring should be buried a max. depth of 6" in order to connect to main supply cable.

7. Attach luminaire to mounting plate and secure with nuts supplied
8. Provide power to luminaire and check for proper operation.

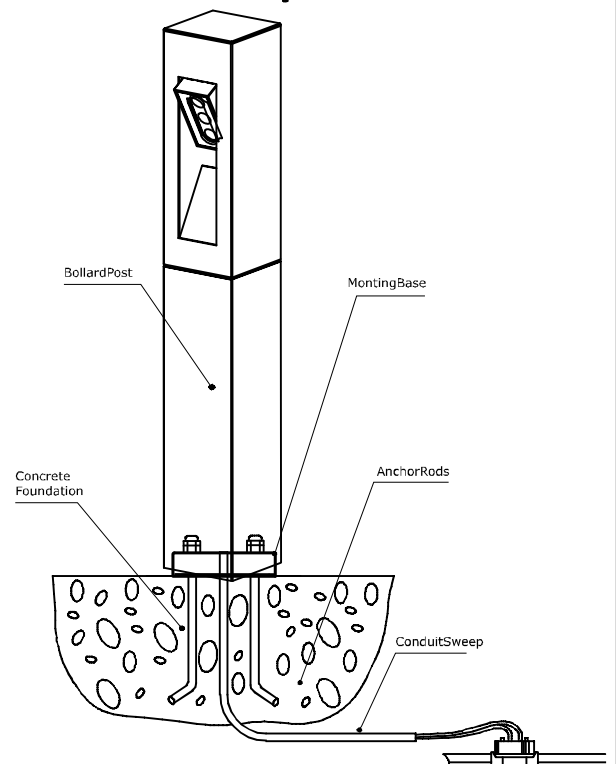
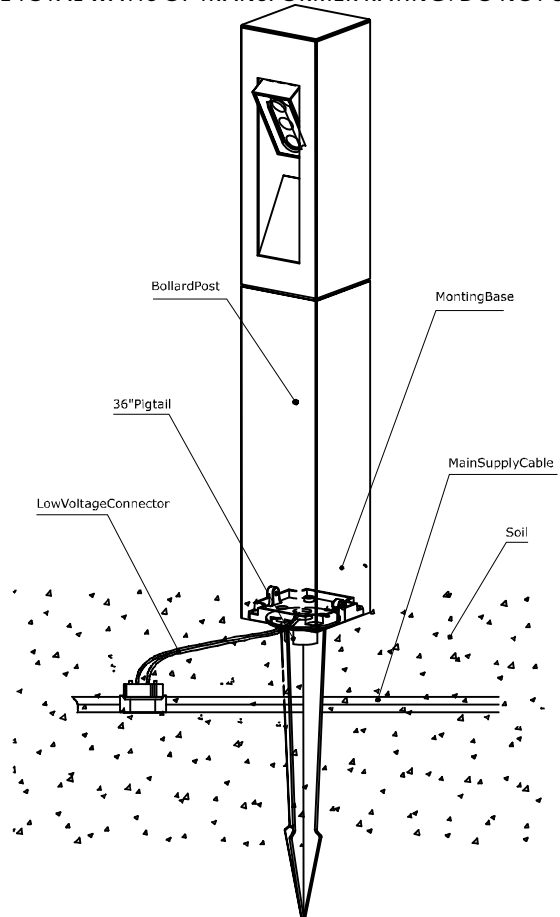



Model E41419-BZ

FOR USE ONLY WITH 12V LOW VOLTAGE LANDSCAPE POWER UNITS THAT DO NOT EXCEED 25 AMPS, 15 VOLT MAXIMUM.

WARNING: Luminaires must be installed in accordance with the National Electrical Code (NEC) and local codes. Failure to do so will void the warranty and may result in serious injury and/or damage to the luminaire.

LUMINAIRES ARE NOT TO BE INSTALLED WITHIN 10 FT. (3.05M) OF A POOL OR SPA. SECONDARY CABLE IS NOT TO BE BURIED MORE THAN 6". WHEN USING MULTIPLE LUMINAIRES, LOAD IS NOT TO EXCEED THE TOTAL WATTS OF TRANSFORMER RATING. DO NOT USE EXTENSION CORDS ON POWER UNITS.

NOTE: Always use UL recognized wire connectors for connections.

NOTE: Alumilux pathway light is provided with a ground stake to facilitate an in-grade installation. However, for a permanent and secure installation a concrete footing support for bollard post is recommended.

Ground Stake Installation

1. To prevent electrical shock, disconnect transformer from electrical supply before installation or service.
2. Dig a hole approximately 3" diameter by 2" deep at selected location.
3. Remove mounting plate from bottom of luminaire
4. Attach ground stake to mounting plate with 2 screws supplied
5. Thread 18/2 direct burial wire through center of ground stake and out exit hole of stake.
6. Connect 18/2 pigtail to main power cable with connector supplied. Turn on power supply to test connection.
7. Push ground stake into ground so that mounting plate is level with ground.
8. Attach fixture to mounting plate with screws provided

Concrete Footing Installation

Installation requires conduit sleeve to allow 36" pigtail to exit through concrete footing.

1. To prevent electrical shock, disconnect transformer from electrical supply before installation or service.
2. Dig a hole approximately 12" diameter by 6" deep at selected location.
3. Install foundation anchors to mounting plate. Position conduit sleeve to be center hole in mounting plate.
4. Using standard masonry procedures, support bollard base in selected location making mounting plate remain above concrete grade.
5. Pour concrete making sure exit end of conduit sleeve reaches outside concrete.
6. Run wire pigtail through bottom sleeve and attach to main power supply cable

NOTE: Luminaires are supplied with 36" of 18-2 cable pigtail for secure connection to main supply cable. Wire is to be protected by routing in close proximity to luminaire. Wiring should be buried a max. depth of 6" in order to connect to main supply cable.

7. Attach luminaire to mounting plate and secure with nuts supplied
8. Provide power to luminaire and check for proper operation.

