

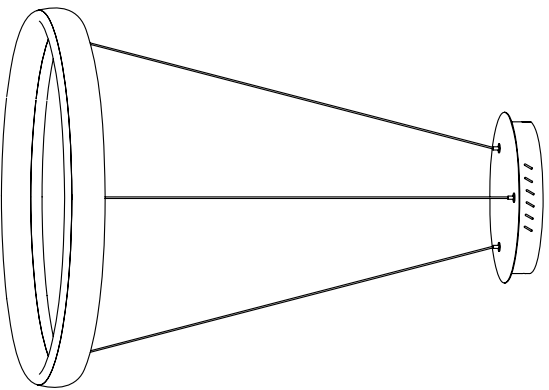

Contemporary Lighting™

PRODUCT NAME: INNER TUBE
ITEM NUMBER: E10030-SN

Please consult your electrician for hanging fixture and wiring.



WARNING: WIRES NEED TO BE CONNECTED TO DRIVER FOUND IN CANOPY AND SHOULD NOT CONNECT DIRECTLY TO POWER SOURCE OR A SHORT MIGHT OCCUR.

Bulb (integrated): 28 Watts LED

This fixture is designed to dim with standard triac forward phase dimmer. Dimming levels will vary by dimmer. Below is a list of recommended dimmers:

- Lutron MACL-153M
- Lutron DVL-153P
- Lutron SCL-153P
- Leviton PL06-10Z
- Leviton 6074-POW

Due to the inrush current wattage should not exceed 150 watts of product for a 600 watt dimmer.

IMPORTANT: Turn off the power at the main fuse or circuit breaker box before starting installation

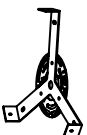

Bracket (A)

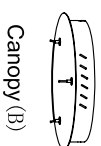

Canopy (B)

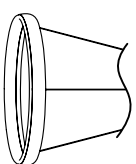

Body (C)

Locate all hardware & components before discarding packaging

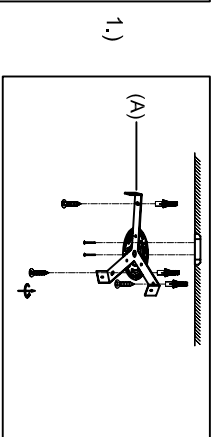
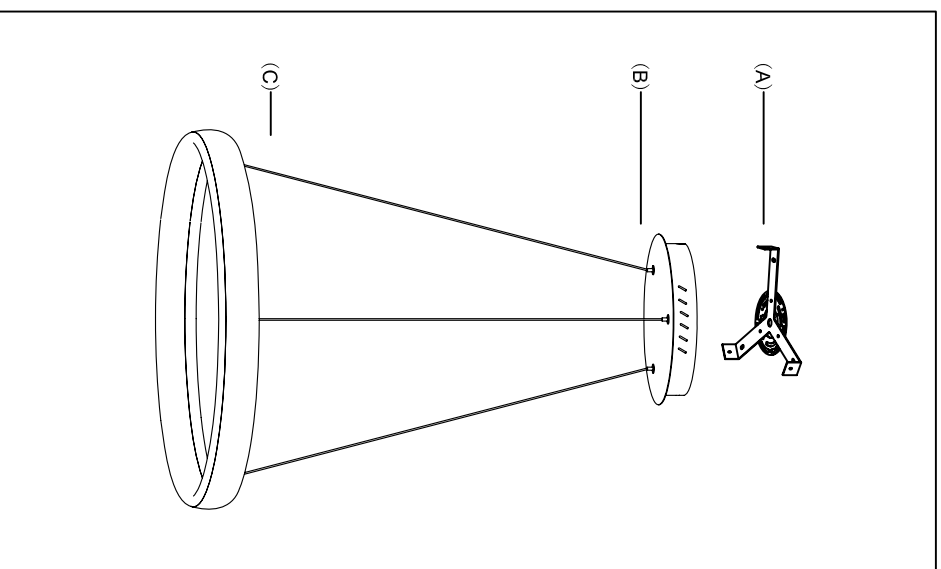

1.)

Step 1: Remove Bracket (A) from fixture and install to electrical box.

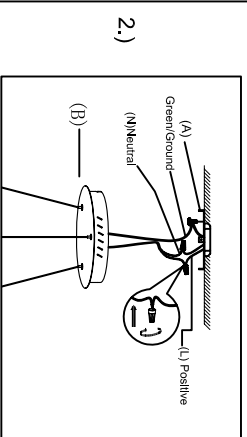

2.)

Step 2: Wire fixture to wires in outlet box. Install Green wire to Ground Screw.

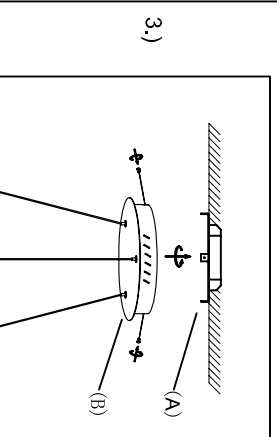

3.)

Step 3: Adjust wire length to desired hanging height. Install Canopy (B) to Bracket (A) and tighten screws at the end of canopy to secure.

Cleaning & Care:
Clean with soft cloth and a mild detergent.
Do not use abrasive cleaner.