

Contemporary Lighting

PRODUCT NAME: Cascada
ITEM NUMBER: E20794-20

Please consult your electrician for hanging fixture and wiring.

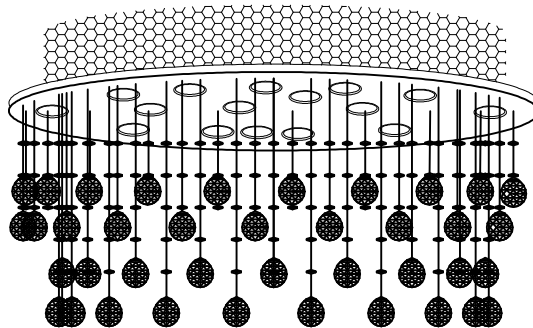

Caution: Xenon bulbs get very hot and may burn you. Always make sure bulbs are off for a minimum of 10 minutes before handling. Fixture may be dimmed using an electronic low voltage dimmer.

IMPORTANT: Turn off the power at the main fuse or circuit breaker box before starting installation

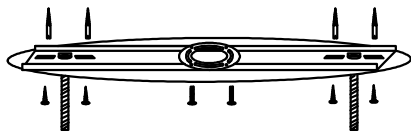

A

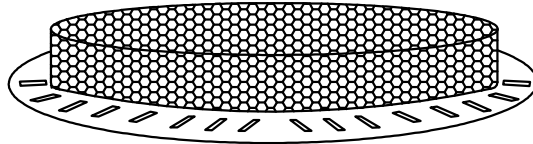

B

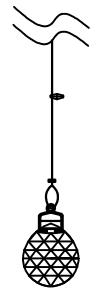

C

Locate all hardware & components before discarding packaging

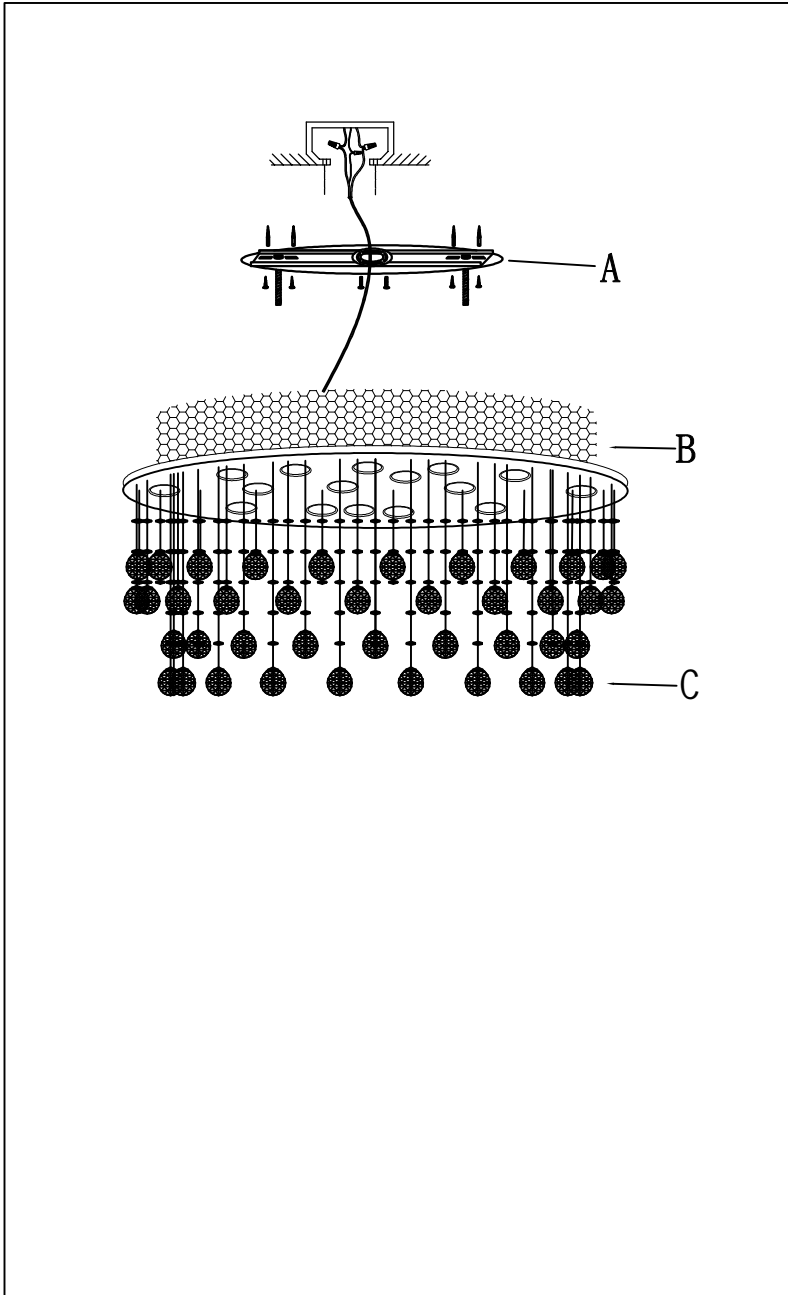

1.)

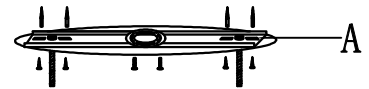

Step.1: Install mounting bracket (A) to the electrical box. Drill holes using 3/16" ± drill bit where marked. Install mounting bracket to outlet box and attach anchors to secure fixture.

2.)

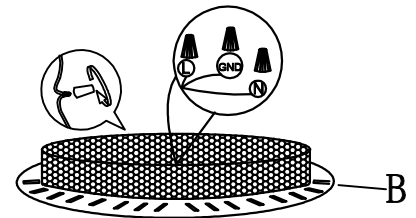

Step.2: Wire fixture to wires in outlet box. Green wire is for Ground.

3.)

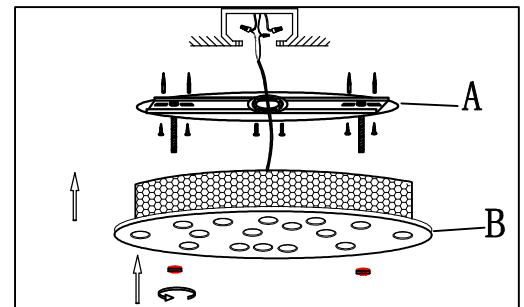

Step.3: Install canopy (B) to bracket (A) and tighten finials until flush with the ceiling.

4.)

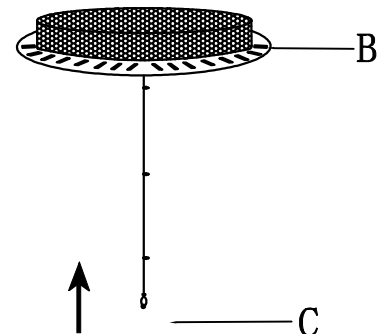

Step.4: Hang crystals (C) according to diagram on the following page.

Cleaning & Care:

Clean with soft cloth and a mild detergent. Do not use abrasive cleaner.



Contemporary
Lighting

Model E20794-20 Crystal Diagram

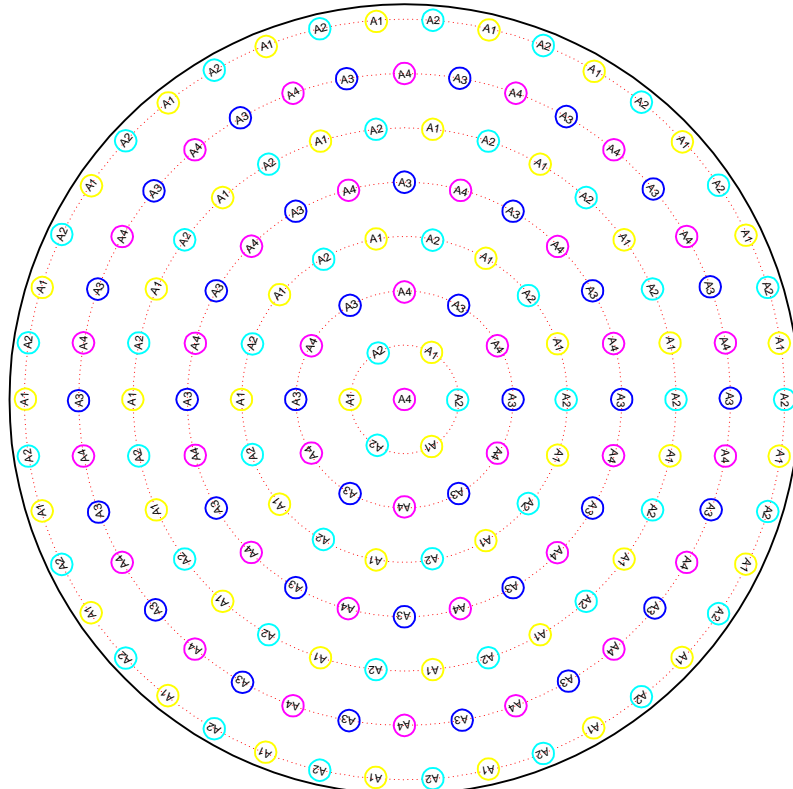
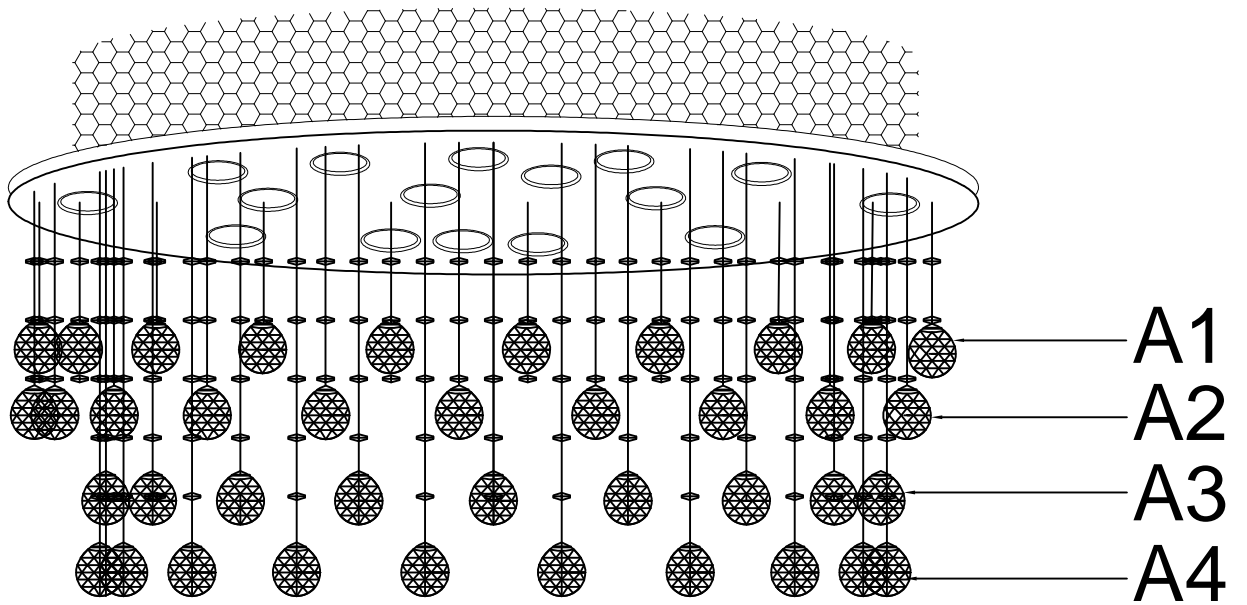

IMPORTANT: Turn off the power at the main fuse or circuit breaker box before starting installation

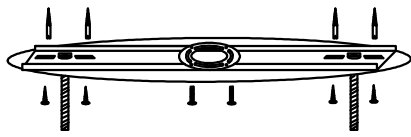

A

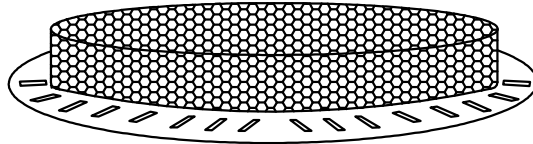

B

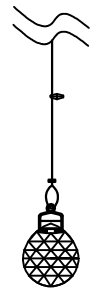

C

Locate all hardware & components before discarding packaging

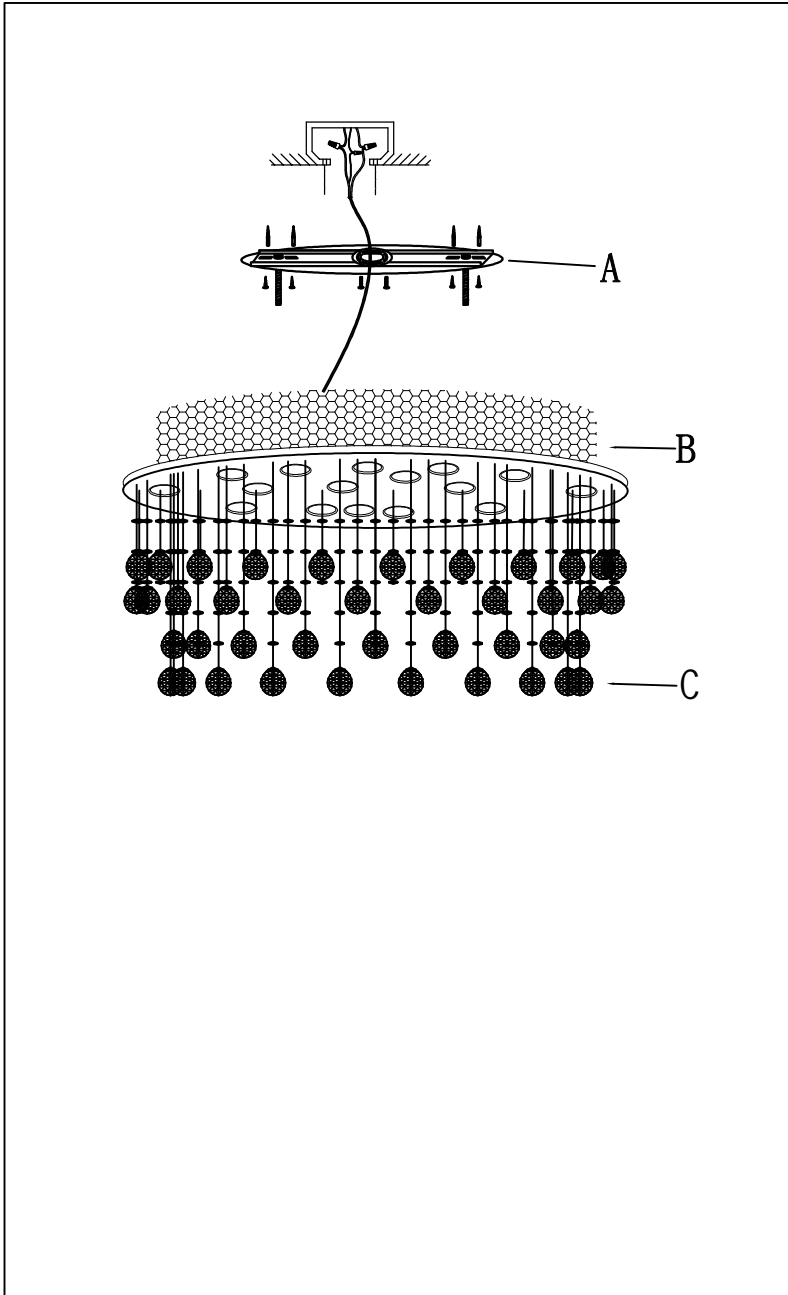

1.)

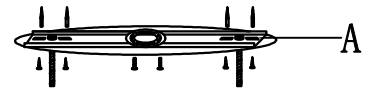

Step.1: Install mounting bracket (A) to the electrical box. Drill holes using 3/16" ± drill bit where marked. Install mounting bracket to outlet box and attach anchors to secure fixture.

2.)

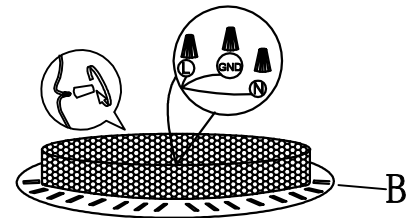

Step.2: Wire fixture to wires in outlet box. Green wire is for Ground.

3.)

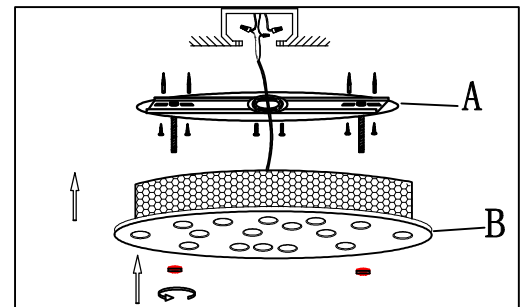

Step.3: Install canopy (B) to bracket (A) and tighten finials until flush with the ceiling.

4.)

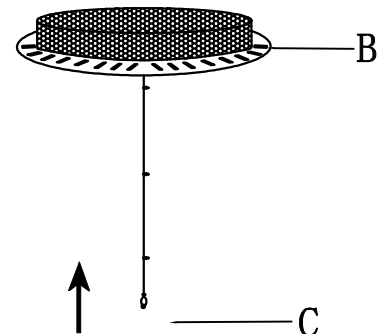

Step.4: Hang crystals (C) according to diagram on the following page.

Cleaning & Care:

Clean with soft cloth and a mild detergent. Do not use abrasive cleaner.



Contemporary Lighting

Model E20794-20 Crystal Diagram

