

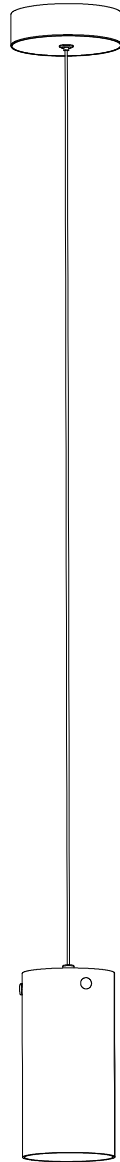

Contemporary
Lighting™

Item/Model Number: E21181

Highball LED Mini Pendant







Lamping | Ampoule: LED Integrated 10W

Please consult a qualified electrician prior to install

Veuillez consulter un électricien qualifié pour suspendre le luminaire et le câblage.

Made in China | Fabrique en Chine | Hecho en China

LED LOW-VOLTAGE INSTRUCTIONS

| English Before Getting Started | Français Avant de Commencer | Español Antes de Comenzar |
|--|--|---|
| Read the instructions carefully prior to assembling the product. | Lire attentivement les instructions avant d'assembler le produit. | Lea atentamente las instrucciones antes de ensamblar el producto. |
| When you open the package with a sharp tool like a box knife, be careful not to damage the components inside. | Lorsque vous ouvrez le paquet avec un outil pointu comme un couteau de coupe, veillez à ne pas endommager les composants à l'intérieur. | Cuando abra el paquete con una herramienta afilada como un cuchillo de corte, tenga cuidado de no dañar los componentes dentro. |
| Carefully remove all packaging materials and retain for future use. | Retirez soigneusement tous les matériaux d'emballage et conservez-les pour un usage ultérieur. | Retire con cuidado todos los materiales de embalaje y consérvelos para usarlos en el futuro. |
| Keep all hardware parts and packaging out of reach of children. | Conservez toutes les pièces matérielles et les emballages hors de portée des petits enfants. | Mantenga todas las piezas y embalajes de hardware fuera del alcance de los niños pequeños. |
| Choose a clean, level, spacious assembly area. Avoid hard surfaces that may damage the product. | Choisissez une zone d'assemblage propre, de niveau et spacieuse. Évitez les surfaces dures qui pourraient endommager le produit. | Elija una zona de ensamblaje limpia, nivelada y espaciosa. Evite superficies duras que puedan dañar el producto. |
| Ensure that you have all required contents for complete assembly. | Assurez-vous que vous avez tous les contenus requis pour l'assemblage complet. | Asegúrese de que tiene todos los contenidos necesarios para el ensamblaje completo. |
| Take care when lifting. Assemble the product in close proximity to where you intend to install it. | Prenez soin de soulever. Assemblez le produit à proximité de l'endroit où vous comptez positionner l'élément. | Tenga cuidado al levantar. Ensamble el producto cerca de donde tiene la intención de posicionar el artículo. |
| Do not over tighten the screws and bolts as this may damage the threads. | Ne serrez pas trop les vis et les boulons car cela pourrait endommager les filets. | No apriete excesivamente los tornillos y pernos, ya que esto puede dañar los hilos. |
| Do not let children play with this product. | Ne laissez pas les enfants jouer avec ce produit. | No permita que los niños jueguen con este producto. |
|  Risk of suffocation! Keep packaging materials away from children. |  Risque asphyxiel! Tenez tous les matériaux emballage à l'écart des enfants |  Riesgo de sofocación! Mantenga los materiales de emb/alaje lejos de los niños. |
| Lamp Care Instructions | Entretien de la Lampe | Instrucciones de Lámparas |
| Carefully read through the instruction sheet before assembly and using the product. | Avant de procéder à l'assemblage et à l'utilisation de la lampe, lisez attentivement le mode d'emploi. | Lea cuidadosamente la hoja de instrucciones (si fue proporcionada) antes de armar y utilizar la lámpara. |
|  Caution there is a risk of shock! Disconnect from power source before assembling or cleaning. |  Pour éviter tout risque d'électrocution, débranchez la lampe de la prise électrique avant de procéder à l'assemblage ou au nettoyage de la lampe. |  Peligro por descarga eléctrica. Desconecte la lámpara de la fuente de electricidad antes de armarla o limpiarla. |
| Switch off, unplug and allow bulb to cool before replacing bulb or cleaning. | Avant de remplacer ou de nettoyer l'ampoule, éteignez et débranchez la lampe. | Apáguela, desenchúfela y deje que la bombilla se enfríe antes de reemplazarla o limpiarla. |
| Only use the recommended bulb type and do not exceed the maximum wattage as it could cause fire. | Afin d'éviter tout risque de feu, utilisez le type et la puissance d'ampoule recommandés. | Solo utilice el tipo de bombilla recomendado y no exceda la potencia eléctrica máxima ya que puede causar un incendio. |
| Check the product cord to be sure is free torn or frayed. | Ne branchez pas la lampe si son cordon d'alimentation est déchiré ou effiloché | No conecte la lámpara si el cable eléctrico está dañado o deshilachado. |
|  WARNING: Wires must be connected to low voltage driver and should not be connected directly to live wire or a short may occur. |  AVERTISSEMENT : Les fils doivent être connectés au conducteur et ne doivent pas être connectés directement aux fils sous tension |  ADVERTENCIA: Los cables deben estar conectados al controlador y no deben conectarse directamente al cable activo |
| Cleaning & Maintenance | Nettoyage et Maintenance | Limpeza y Mantenimiento |
| On polished finishes, often using talc powder can reduce the appearance of fingerprints and other smudges. | Sur les finitions polies, souvent en utilisant la poudre de talc réduit l'apparence des empreintes digitales et d'autres taches. | En acabados pulidos, a menudo usando polvo de talco reduce la aparición de huellas dactilares y otras manchas. |
| For respective shade surfaces, use the appropriate cleansers, i.e. glass cleaner, stone polish, & wood polish. | Pour les surfaces d'ombrage respectives, utilisez les nettoyants appropriés, c'est-à-dire le nettoyant pour vitres, vernis à pierre et le vernis à bois. | Para las respectivas superficies de sombra, utilice los limpiadores apropiados, es decir, limpiador de vidrio, esmalte acrílico y pulido de madera. |
| Clean with soft cloth and a mild detergent. Do not use abrasive or harsh cleaners. | Nettoyer avec un chiffon doux et un détergent doux. N'utilisez pas de nettoyant abrasif. | Utilice un trapo limpio, suave y seco que no raye ni manche la superficie cuando quite el polvo. |
| Periodically (every 90-180 days) make sure that the screws are fully tightened. | Périodiquement (tous les 90-180 jours), assurez-vous que les vis sont bien serrées. | Periódicamente (cada 90-180 días) asegúrese de que los tornillos estén bien apretados. |
| Prolonged exposure to heat sources may cause glazing, melting and scorching, or even cause color to fade. | Si le tissu subit une exposition prolongée aux sources de chaleur, il pourrait commencer à reluire, à roussir, à s'estomper ou même à se décolorer. | La exposición prolongada a las fuentes de calor causa cristalización, derretimiento, quemadura y decoloración del tapizado. |

Eng

PARTS

Before getting started, ensure the package contains the following components:

Fra







PIÈCES

Antes de comenzar, asegúrese de que el paquete contenga los siguientes componentes:

Esp

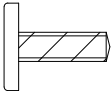
PARTES

Avant de commencer, assurez-vous qu le paquet contient les composants suivants:

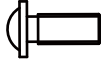
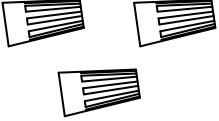
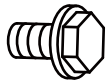
| | | | | | |
|---|---|----|---|--|----|
| A |  | x1 | G |  EGLS21181 | x1 |
| | | | H |  | x3 |
| | | | I |  | x3 |
| B |  | x1 | J | <p>NOVBO LED lighting power Puissance d'éclairage LED Model: NE009277025-2GH Input/Entrée: 120-277Vac 0.32A 50/60Hz Output/Sortie: 18-40Vdc 250mA Input Power/Puissance d'entrée: 9W Max Dimmable at Vin/Dimmable at Vin=120Vac PF >0.9 at Vin=120Vac/PF>0.9 avin =120VaG</p> <p>Size: 2.55"x1.18 W"x0.9"H</p> | x1 |
| C |  (8#-32)" *25 | x2 | | | |
| D |  G5/32" *10 | x2 | | | |
| E |  | x3 | | | |
| F |  5/32*6 | x1 | | | |

This fixture is equipped with an LED driver, please refer to the **Wiring Diagram** for more details
Ce luminaire est équipé d'un pilote a LED, veuillez vous référer au **Schéma De Câblage** pour plus de détails
Este accesorio está equipado con un controlador LED, por favor consulte el **Diagrama De Cableado** para obtener más detalles.

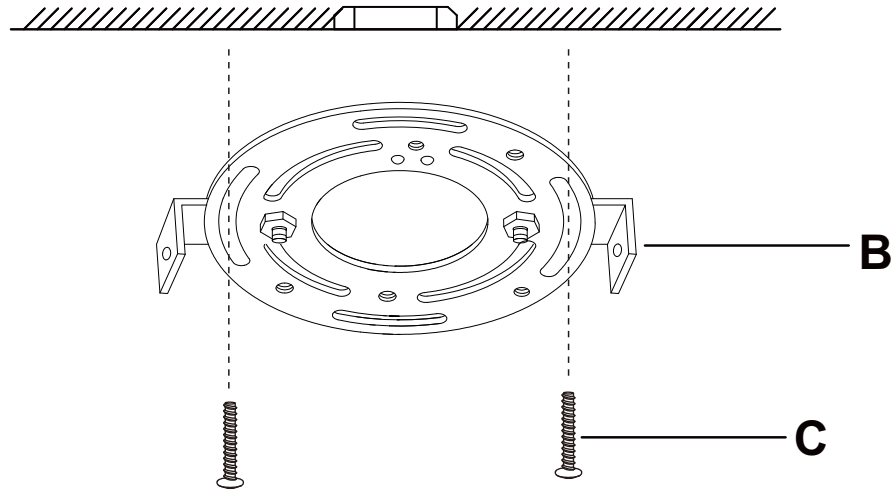

1.

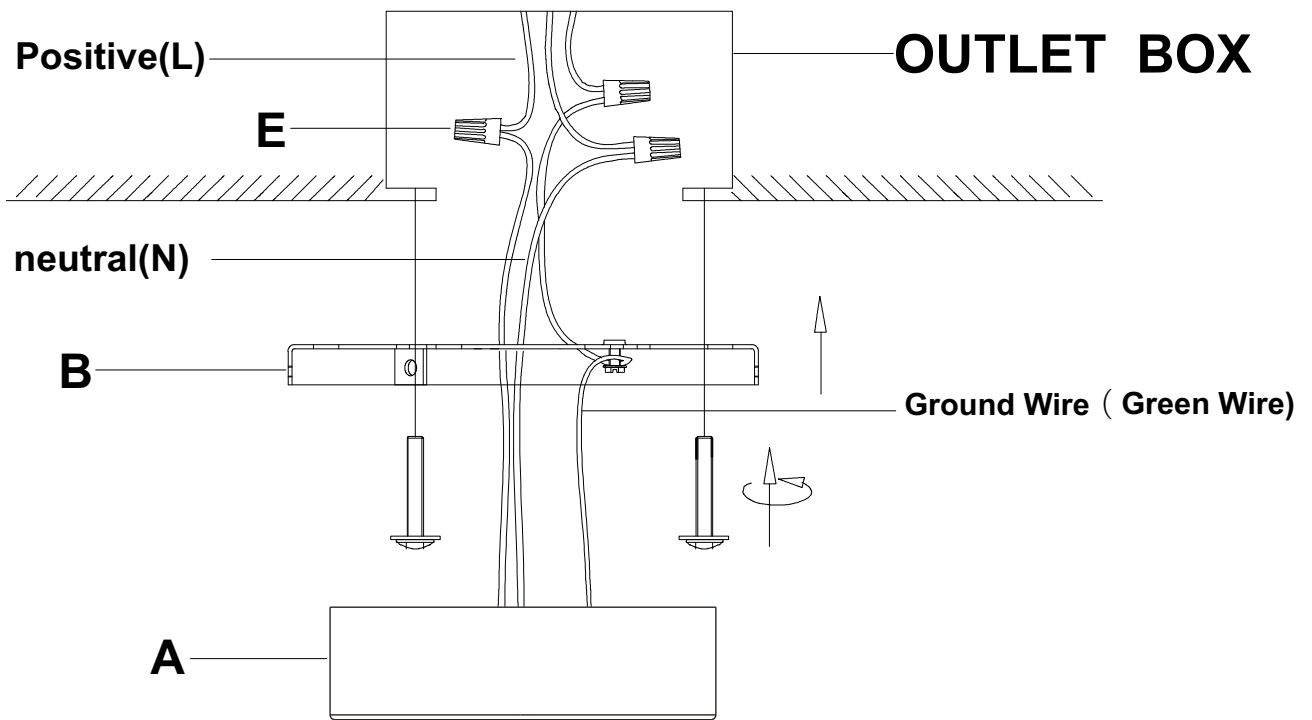

2.

This fixture is equipped with an LED driver, please refer to the **Wiring Diagram** for more details
Ce luminaire est équipé d'un pilote a LED, veuillez vous référer au **Schéma De Câblage** pour plus de détails
Este accesorio está equipado con un controlador LED, por favor consulte el **Diagrama De Cableado** para obtener más detalles.

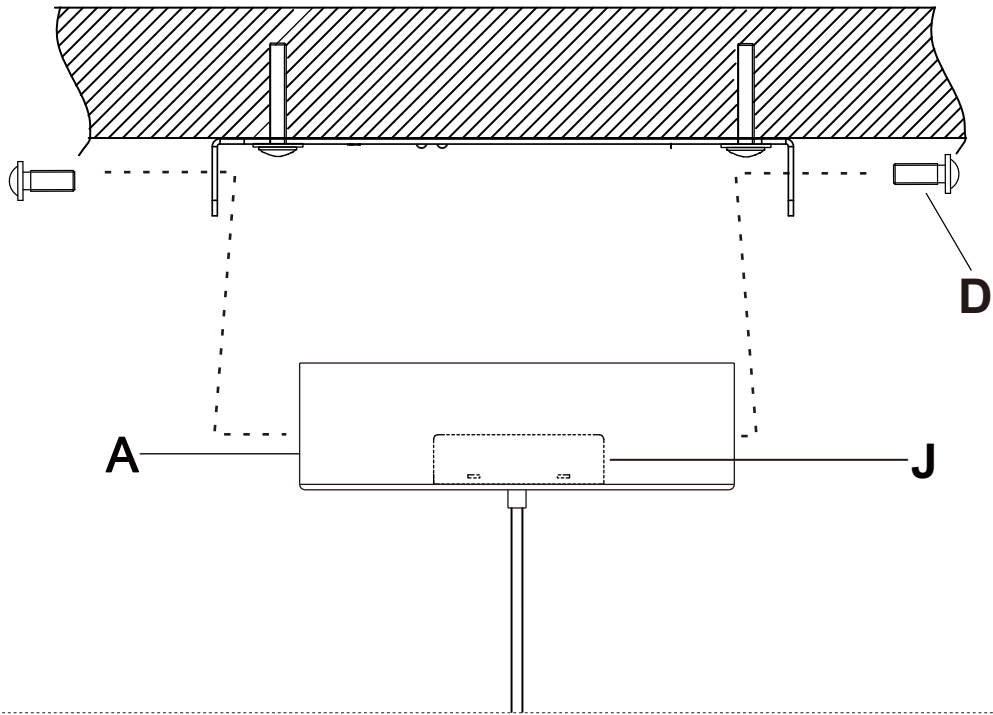

3.

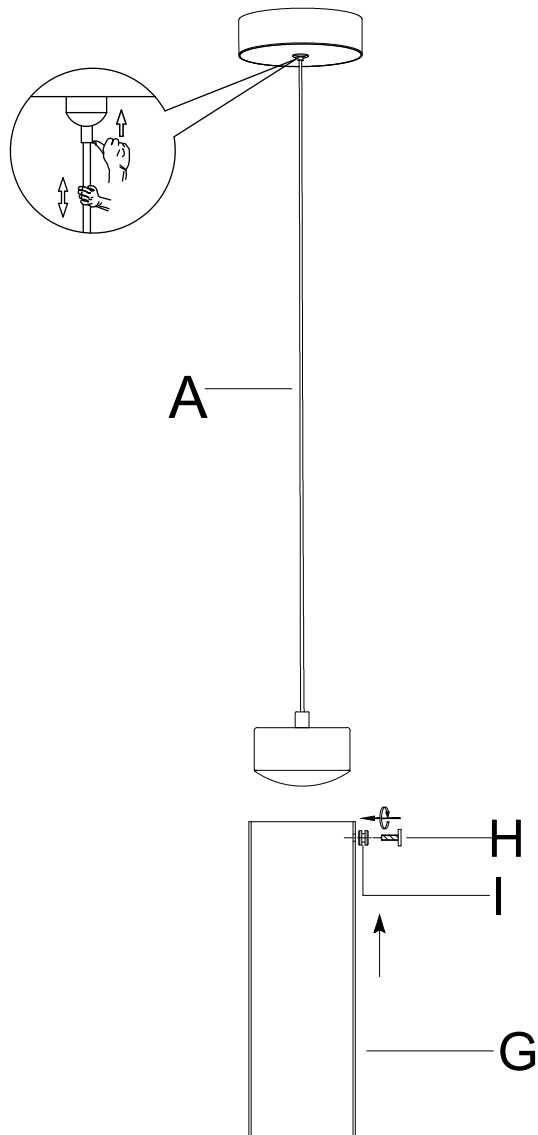

4.



ITEM/MODEL: E21181

MUST be installed by an experienced professional
CRITICAL KNOWLEDGE of electronic lighting systems required

IMPROPER WIRING and/or INCORRECT DIMMER use can cause CATASTROPHIC DAMAGE!

THIS FIXTURE MUST BE INSTALLED with a COMPATIBLE DIMMER SWITCH

DO **NOT** CUT FACTORY-MADE CONNECTIONS.

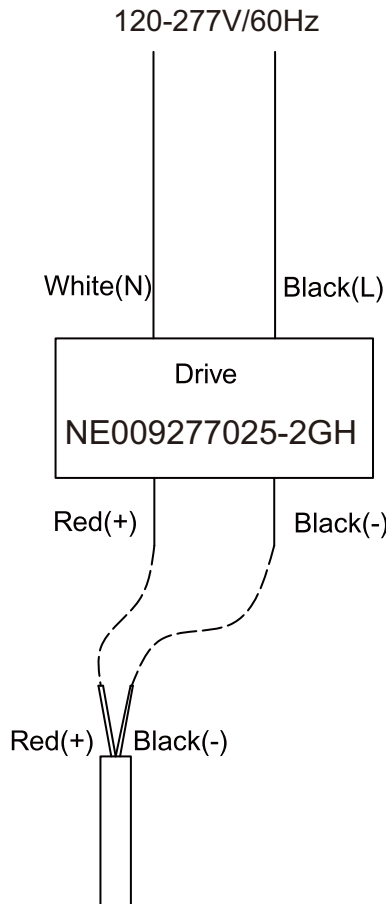

FACTORY CONNECTIONS

(+) INNER CONDUCTOR | OUTER MESH (-)

LED DRIVER DIAGRAM

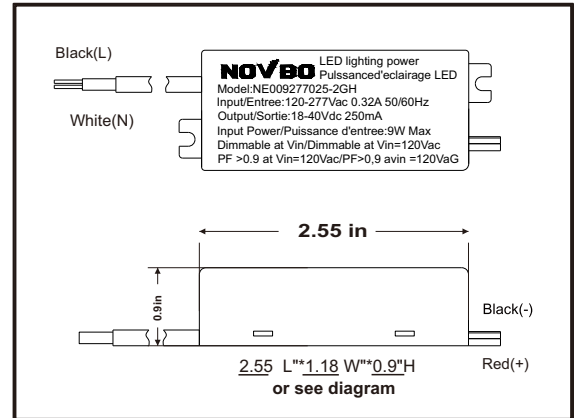

SCHEMATIC
FOR GENERAL
REFERENCE ONLY

VERIFIED LIST OF TESTED DIMMERS

- Lutron Diva DVCL-153P
- Lutron Diva DVELV-300P
- Lutron Diva Caseta PD-6WCL
- Lutron Maestro MACL-153M
- DEAKO-Smart Dimmer
- DEAKO-Single Dimmer
- LEVITON 6672-L
- LEVITON DSL06

GENERAL COMPATIBILITY

**TRIAC / FORWARD PHASE
ELV / REVERSE PHASE**

Only at 120VAC

Due to inrush current, wattage should not exceed 150W on a 600W dimmer

IMPORTANT!

If the control is not paired properly to LED fixtures, irreparable damage may occur.

If the dimmer you are using is not listed here, consult a lighting professional or view our Dimming Compatibility Chart online:

www.et2online.com/led-dimmer

MUST be installed by an experienced professional
CRITICAL KNOWLEDGE of electronic lighting systems required