

INSTALLATION INSTRUCTION

Item No.: E21800-20PC

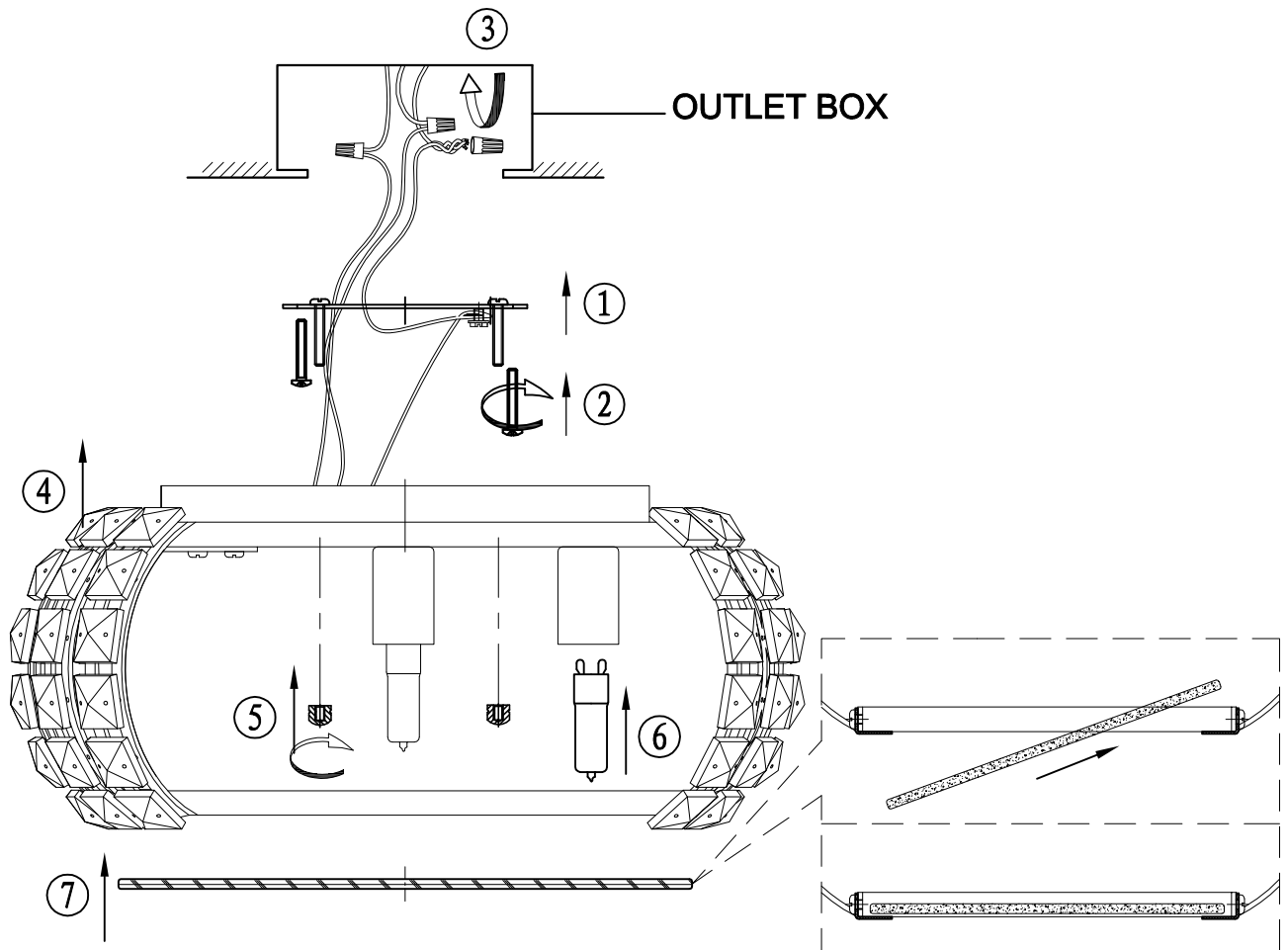

FEATURE

- Lamp Type: G9 4xMAX 40W 120V~ 60Hz
- The lamp can be only indoor used.