

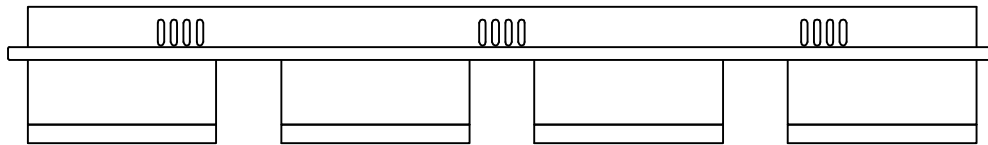

Contemporary Lighting

PRODUCT NAME: Pizzazz
ITEM NUMBER: E24464-160

Please consult your electrician for hanging fixture and wiring.

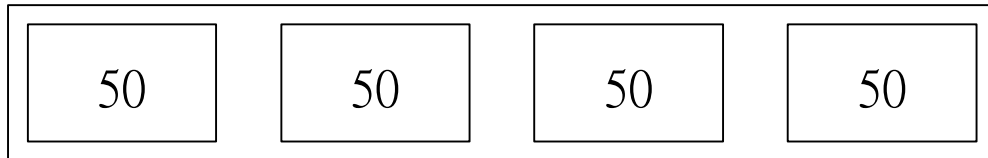

The fixture is designed to dim with a standard Triac forward phase dimmer. Dimming levels will vary by dimmer.

Below is a list of recommended dimmers:

- Lutron MACL-153M
- Lutron DVL-153P
- Lutron SCL-153P
- Leviton IPL06-10Z
- Leviton 6674-POW

Due to inrush current wattage should not exceed 150 watts of product for a 600 watt dimmer.

Warning! Wires need to be connected to driver found in canopy and should not be connected directly to power source or a short may occur.

IMPORTANT: Turn off the power at the main fuse or circuit breaker box before starting installation

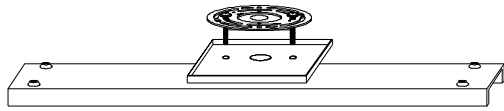

(A)
Mounting Bracket



(B)
Screw Nut



(C)
Anchors

Locate all hardware & components before discarding packaging

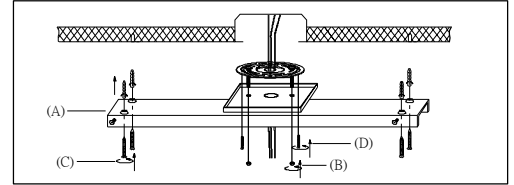
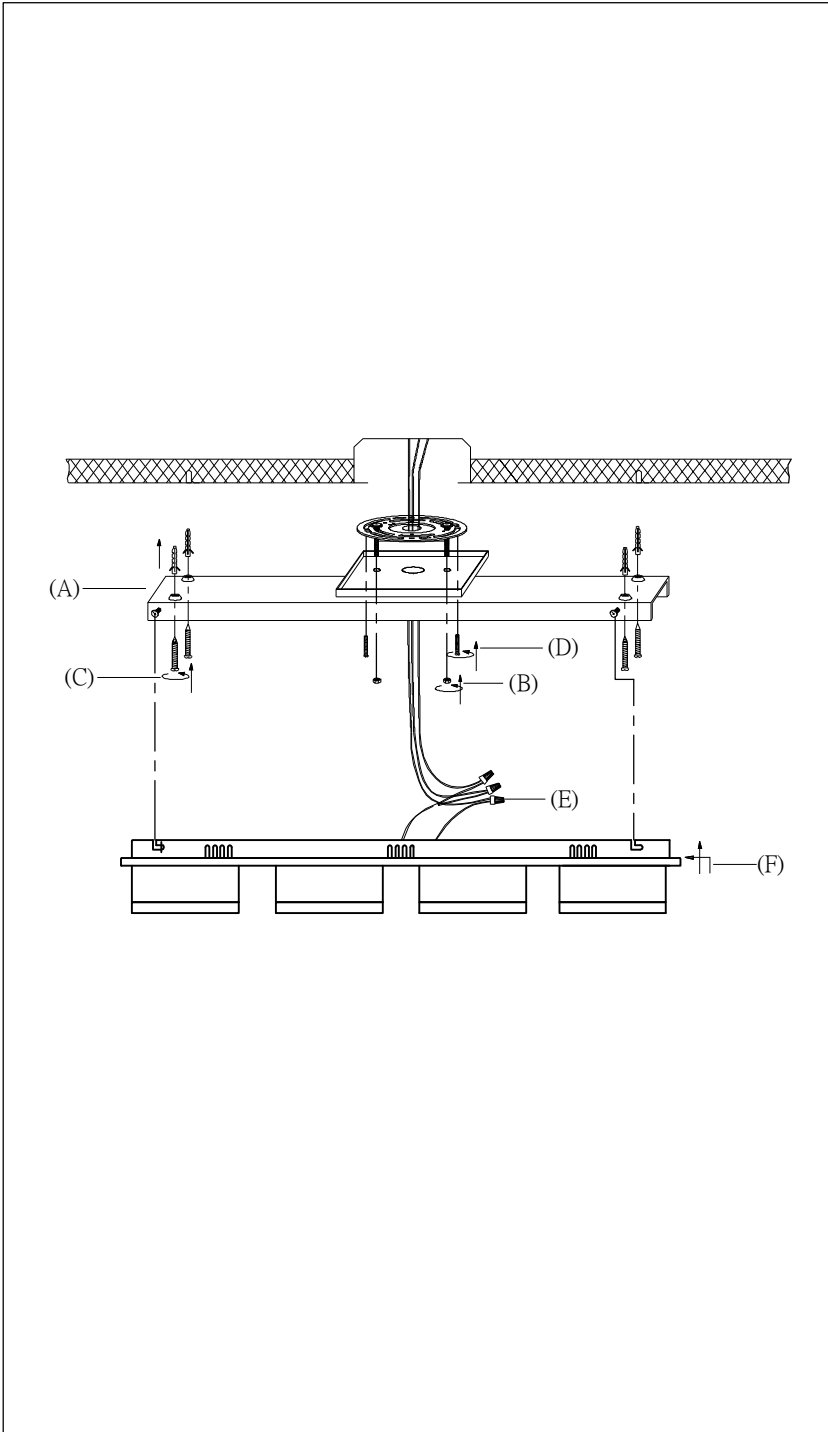

1.)

Step.1: Remove mounting bracket from fixture and install to electrical box using screws (D). Mark where screws at ends of bracket (A) meet the ceiling. Remove mounting bracket (A) from ceiling. Drill holes using $3/16" \pm$ drill bit where marked. Install mounting bracket (A) to outlet box by attaching anchors (C) and screw nuts (B) to secure bracket at ends.

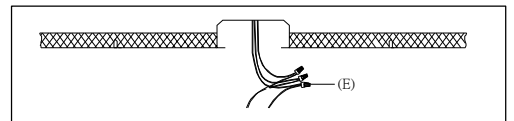

2.)

Step.2: Wire fixture to wires (E) in outlet box. Copper wire is for Ground.

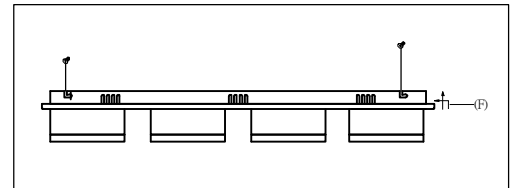

3.)

Step.3: Install fixture to mounting bracket (A) and tighten screws (F) at the ends so that fixture meets the wall.

Cleaning & Care:

Clean with soft cloth and a mild detergent.
Do not use abrasive cleaner.