

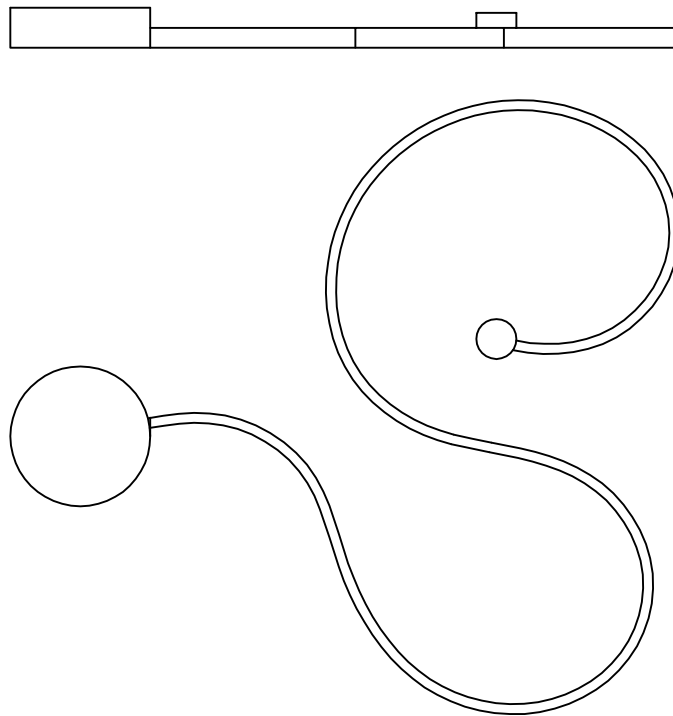

Contemporary Lighting

PRODUCT NAME: Serpent
ITEM NUMBER: E24531-WT

Please consult your electrician for hanging fixture and wiring.



The fixture is designed to dim with a standard Triac forward phase dimmer. Dimming levels will vary by dimmer.

Below is a list of recommended dimmers:

- Lutron MACL-153M
- Lutron DVL-153P
- Lutron SCL-153P
- Leviton IPL06-10Z
- Leviton 6674-POW

Due to inrush current wattage should not exceed 150 watts of product for a 600 watt dimmer.

Warning: Wires need to be connected to driver found in canopy and should not be connected directly to power source or a short may occur.

IMPORTANT: Turn off the power at the main fuse or circuit breaker box before starting installation



(A)
Mounting bracket



(C)
Decorative caps



(C)
Decorative caps

Locate all hardware & components before discarding packaging

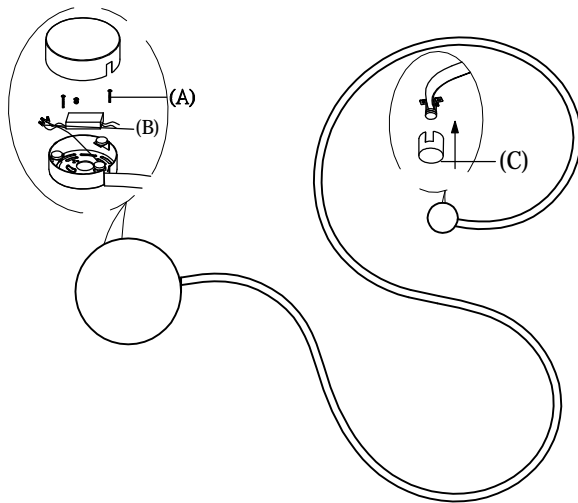

1.)

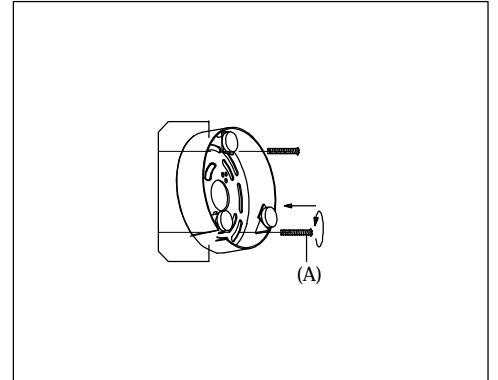

Step.1: Install mounting bracket to outlet box(A)

2.)

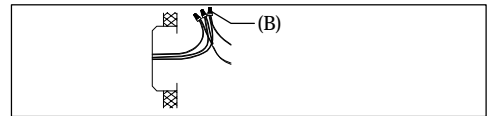

Step.2: Wire fixture to wires in outlet box. Green/Copper wire is for Ground.(B)

3.)

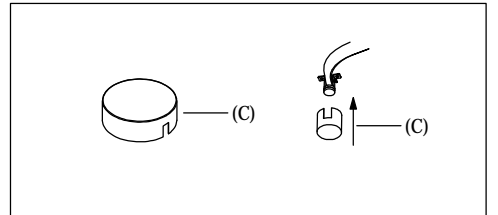

Step.3: Secure end point of the wall bracket with screws and cover both the mounting bracket and end point with decorative caps.(C)

Cleaning & Care:

Clean with soft cloth and a mild detergent.
Do not use abrasive cleaner.