

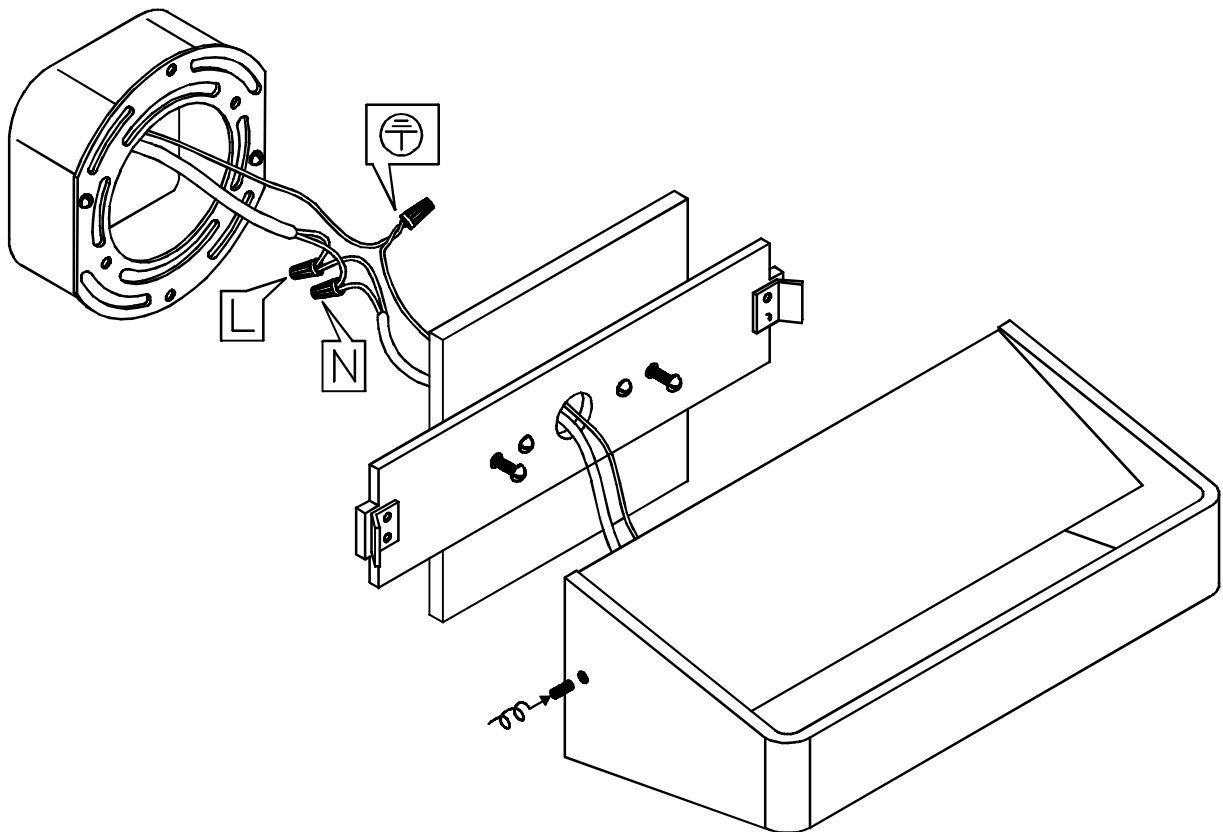

1. Turn breaker off for circuit on outlet, where fixture is to be installed.
2. Remove mounting bracket from fixture and install it to electrical box.
3. Wire fixture to wires in outlet box. Green wire is for Ground.
4. Install fixture to back-plate and tighten wormscrews so that fixture meets the wall.

Warning:

1. These fixtures contain electronic drivers than cannot be operated with a dimmer of any kind. Doing so will void the warranty.
2. To prevent water intrusion, caulk around back-plate where fixture meets the wall using outdoor silicone sealant.
3. Wires need to be connected to driver found in canopy and should not be connected directly to power source or a short may occur.





Model E41304-BZ

1. Turn breaker off for circuit on outlet, where fixture is to be installed.
2. Remove mounting bracket from fixture and install it to electrical box.
3. Wire fixture to wires in outlet box. Green wire is for Ground.
4. Install fixture to back-plate and tighten wormscrews so that fixture meets the wall.

Warning:

1. These fixtures contain electronic drivers than cannot be operated with a dimmer of any kind. Doing so will void the warranty.
2. To prevent water intrusion, caulk around back-plate where fixture meets the wall using outdoor silicone sealant.
3. Wires need to be connected to driver found in canopy and should not be connected directly to power source or a short may occur.

