

# Contemporary Lighting

PRODUCT NAME: Alumilux  
ITEM NUMBER: E41534-BZ

Please consult your electrician for hanging fixture and wiring.

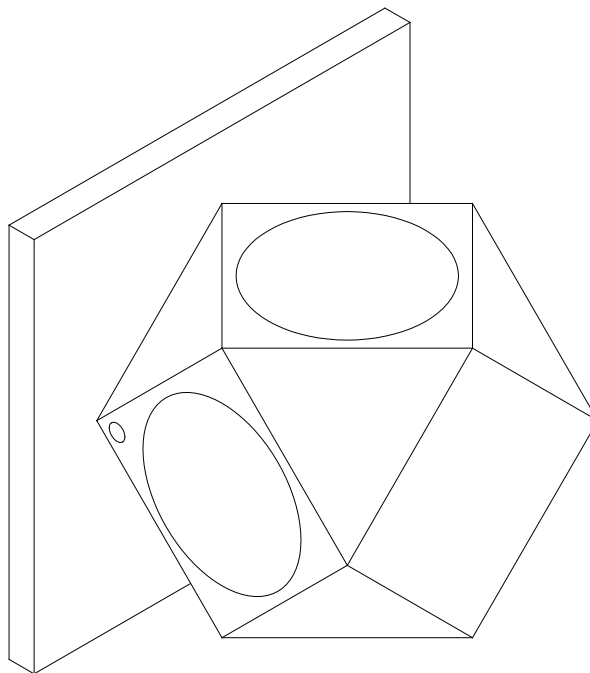

WARNING: Wires need to be connected to driver found in canopy and should not be connected directly to power source or a short may occur.

To prevent water intrusion, caulk around back-plate where fixture meets the wall using outdoor silicone sealant. Leave a small gap at the bottom to allow moisture to exit.

**IMPORTANT:** Turn off the power at the main fuse or circuit breaker box before starting installation

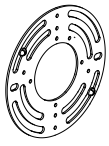

(A)

Mounting bracket

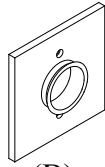

(B)

Backplate



(C)

Wire Nuts (x3)



(D)

Mounting screws (x2)

**Locate all hardware & components before discarding packaging**

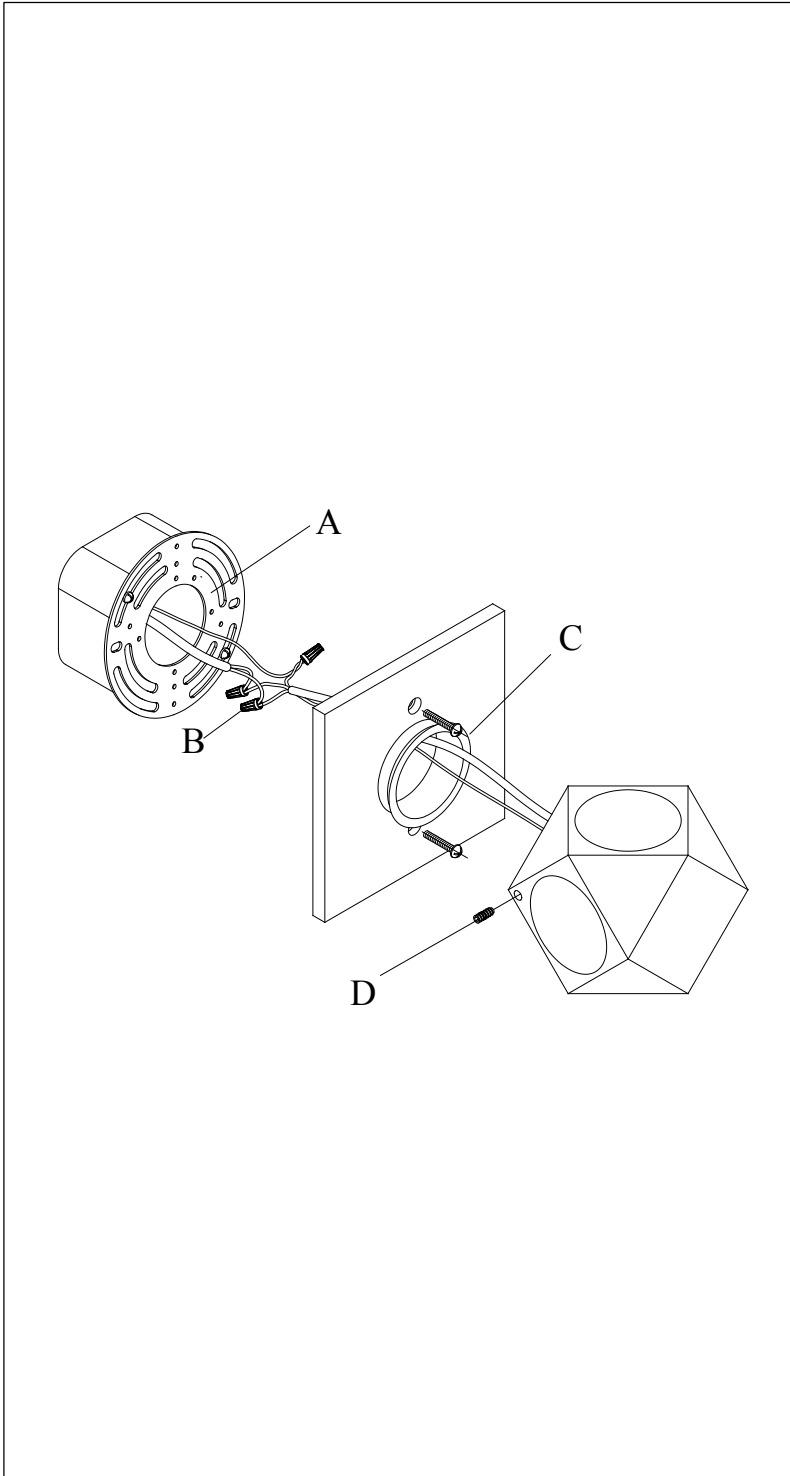

1.)

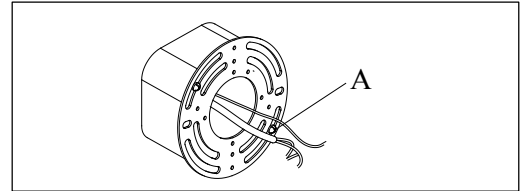

Step.1: Install Mounting bracket(A) to outlet box.

2.)

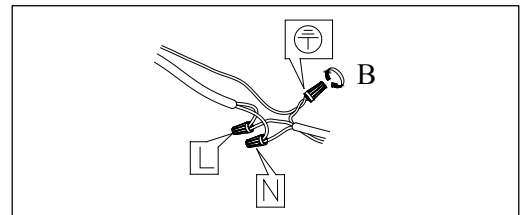

Step.2: Wire fixture to wires in outlet box.  
Green/Copper wire is for Ground.

3.)

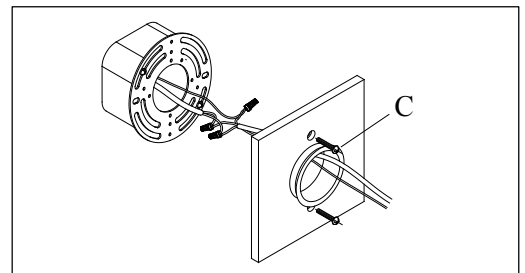

Step.3: Install Backplate(B) to Mounting bracket(A).

4.)

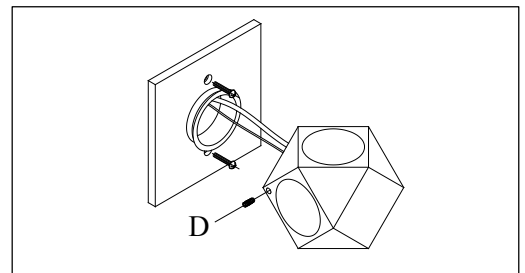

Step.4: Caulk around fixture with outdoor silicone sealant to prevent water intrusion. Leave a small gap at the bottom to allow moisture to escape. Install fixture to back plate (B) and tighten mounting screws (D) to secure.

**Cleaning & Care:**

Clean with soft cloth and a mild detergent.  
Do not use abrasive cleaner.