

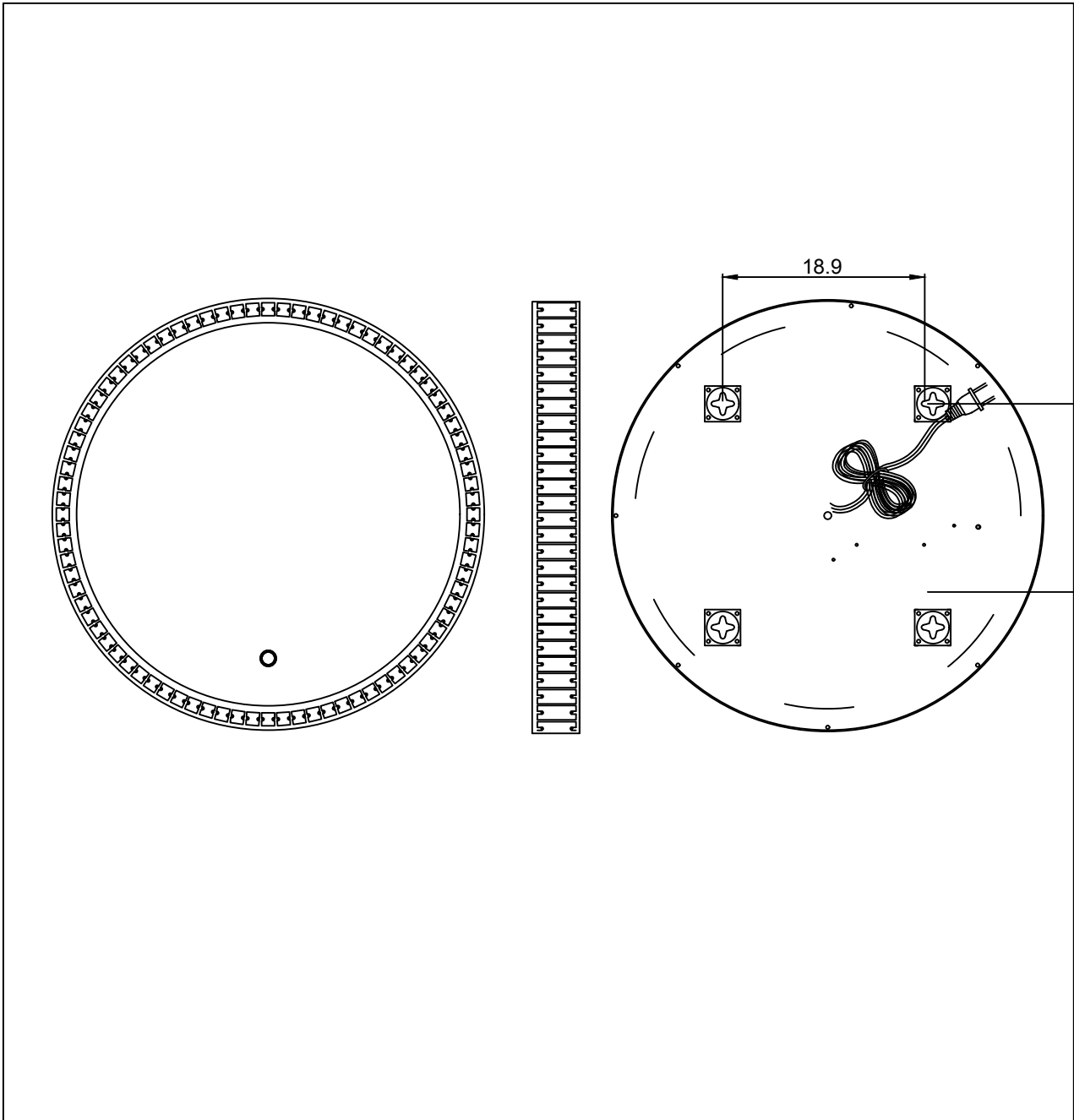

Contemporary Lighting

PRODUCT NAME: LED MIRROR
ITEM NUMBER: E42004-20

Please consult your electrician for installing fixture and wiring.



Light Source: Integrated LED 22W

IMPORTANT:

-Turn off the power at the main fuse or circuit breaker box before starting installation

-This mirror can be mounted over an electrical outlet box or on the wall and plugged into an outlet

-Carefully remove all parts from the box, and place on a flat surface. Throughout the assembly, be careful to avoid scratching the surface of the mirror.

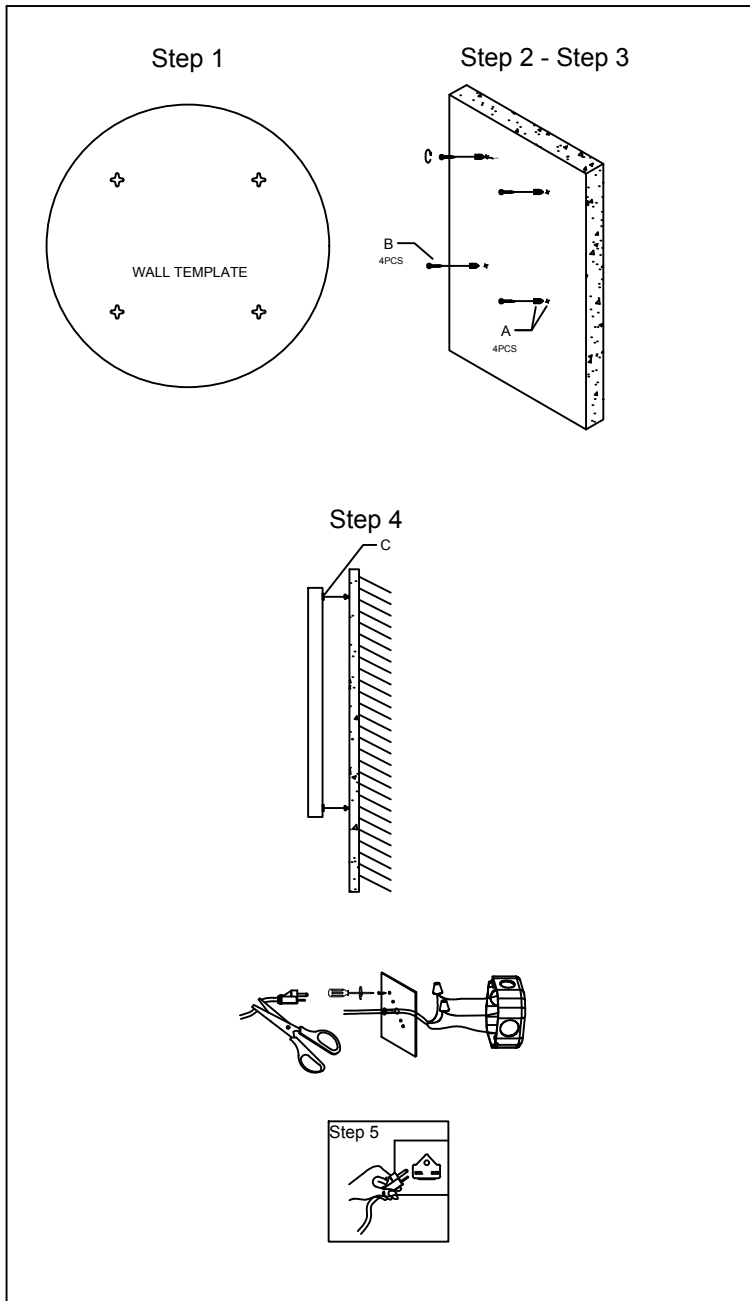

1.) Place the wall template or the mirror on the wall in the location selected for the mirror. Make sure the wall template or mirror is level and in the correct position. Secure the wall template to the wall then mark location of the 4 wall anchors(A) as indicated on the template from the wall. Remove the wall template from the wall.

2.) Create holes on wall marks and screw the (X4) wall anchors (A).

3.) Secure (X4) nails (B) into (X4) wall anchors (A).

4.) Hang (X4) wall hangers (C) on the back of mirror onto (X4) nails (B). If wall is not mounted parallel to floor, repeat step 4.

5.) Plug cord into closest power outlet. OR before step 5, cut the plug and connect the wire with junction box wire.

*IMPORTANT SAFETY INSTRUCTIONS

This mirror has a 3 pins plug, once the plug is cut, the 3 core wire(phase/neutral/ground) will be exposed then can connect with phase/neutral/ground which come out from junction box

Cleaning & Care:

Clean glass with household glass cleanser.