

LETBRO2501



Contemporary  
Lighting™



**CONTINUUM**  
TRACK

# CONTINUUM TRACK

The next generation of track lighting is here with the ultra-slim Continuum series from ET2

Field adjustable track lengths can be extended, connected, or cut to fit the space they are installed. On them, a variety of low voltage light sources can be quickly snapped into place adding and directing light exactly where desired. Various power feed options are available including remote, on-track, or integrated dimmable driver and switch.

Available in Matte Black or Matte White, the track lengths can even be painted to match the exact paint color of the surface they are installed. This adaptable track system makes it simple to design the lighting in your space according to your vision and is only limited by your imagination.

- **Surface Mounted Installation**
- **Mount to both walls and Ceilings**
- **Ultra Slim Profile appears similar to recessed**
- **Various Lighting elements quickly click onto track**
- **Field adjustable**
- **Available in White and Black**
- **24 Volt System**





## ON-TRACK DRIVER

24V Low Voltage Output  
Plug-In and Hardwire Options



**96W On-Track Driver**  
**ETDRV001-24100BK, WT**

11.5"L x 1"W x 2.25"H  
Includes 48" Plug

### INSTALL TRACK 3 WAYS



INSTALL OPTION: PLUG-IN



INSTALL OPTION: HARDWIRE KNOCKOUT

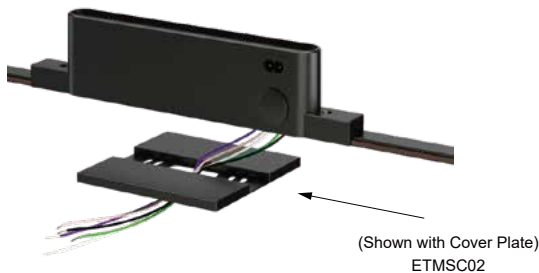

(Shown with Cover Plate)  
ETMSC02

INSTALL OPTION: DISCREETLY WIRE WITHIN

## COVER PLATE ACCESSORIES



**Track Cover Plate**  
**ETMSC02-BK, -WT**  
5"L x 5"W x 0.25"H

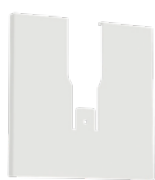

**Track Cover Plate**  
**ETMSC03-BK, -WT**  
5"L x 5"W x 0.25"H

## REMOTE HARDWIRED DRIVER



**Hardwire Driver**  
(Remote Installation)  
**EDHW-2496AL**  
8.5"L x 3.25"W x 1.5"H

## DRIVER & DIMMER SWITCH

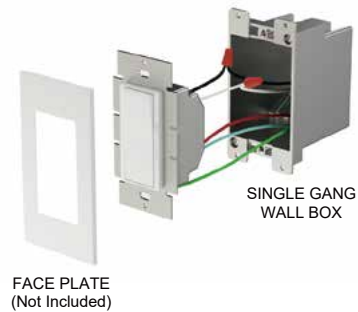

**60W Dimmer Switch**  
**SWT898-2460WT**  
2.25"L x 2"W x 4.25"H

## SPLICE BOX



**Splice Box**  
**ETMSC04-BK, -WT**  
3.5"L x 1.5"W x 0.75"H



Track Length  
(Sold Separately)

## ELECTRICITY FEED & COVER PLATE



**Electricity Module and Cover Plate**  
(Driver not included)  
**ETMSC01-BK, -WT**  
5"L x 5"W x 0.25"H



Track Length  
(Sold Separately)



## SURFACE MOUNTED TRACK



Surface Mount Installation  
 Field Cuttable  
 Various Track Connectors Adaptable  
 Available in Black or White  
 3M Stickers Cover Screw Caps

### TRACK SIZES AVAILABLE:

ETRK25080-BK, -WT 33"  
 ETRK25150-BK, -WT 60"  
 ETRK25200-BK, -WT 80"

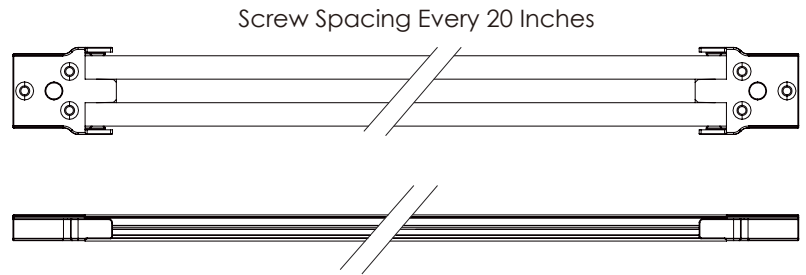

## SURFACE MOUNTED CONNECTORS

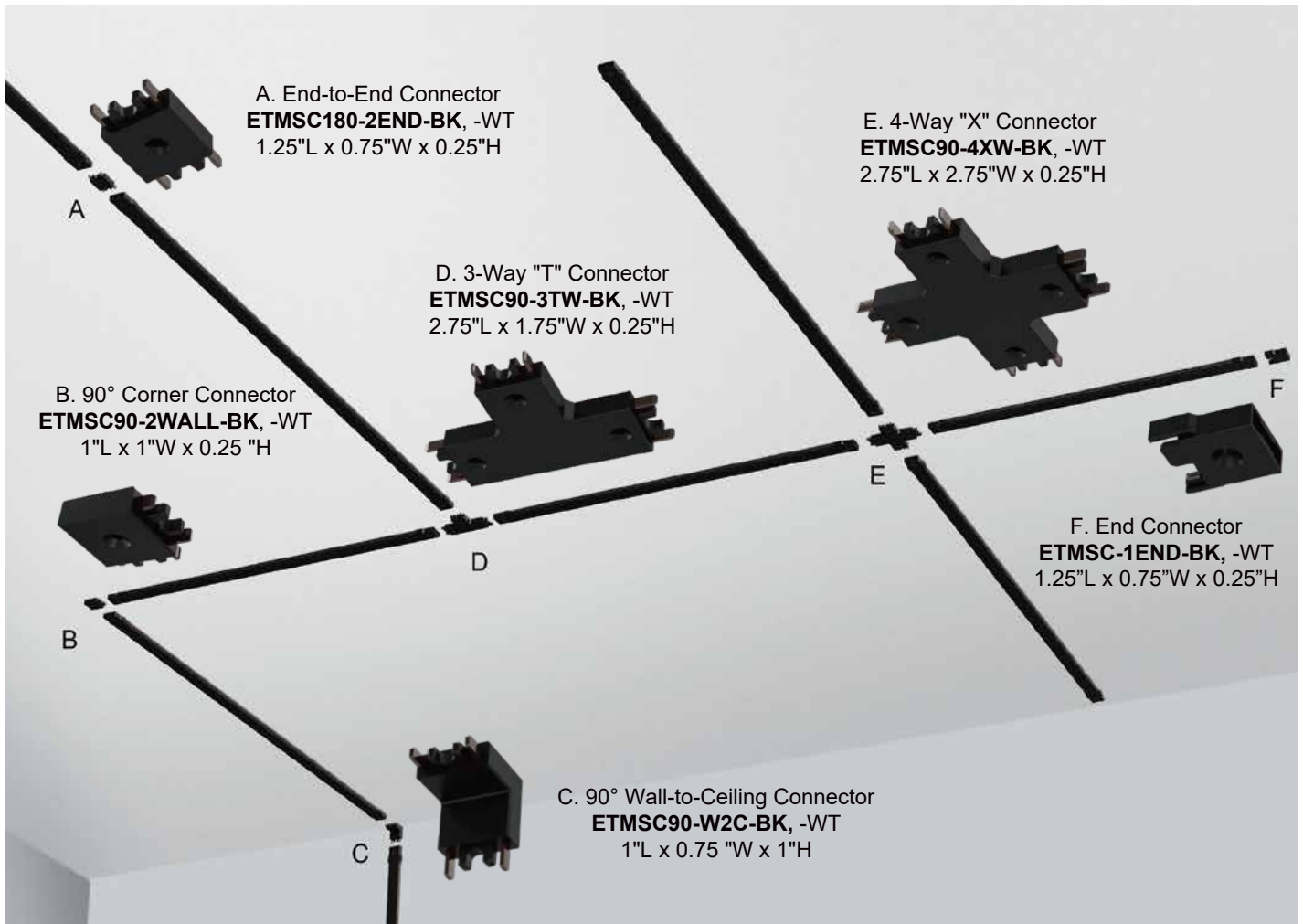

# TRACK LIGHTS

• Flat Lens Diffuser with even light distribution • Available with adjustable gimbal • 24V LED, 3000K Color Temperature

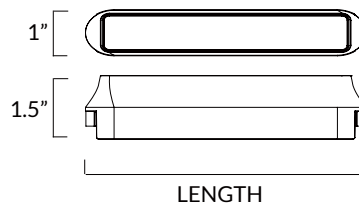

## STANDARD LENS



ETL26212-WT

ETL26216-BK

ETL26218-BK

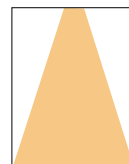

100°

STANDARD LENS

ITEM #	FINISH	LAMPING	DIMENSION	LUMENS			Additional Information
				CRI	INIT.	DEL.	
ETL26212	BK, WT	6W PCB LED 3000K (Inte.)	5"L x 1"W x 1.5"H	90+	600	300	
ETL26216	BK, WT	9W PCB LED 3000K (Inte.)	9"L x 1"W x 1.5"H	90+	900	450	
ETL26218	BK, WT	12W PCB LED 3000K (Inte.)	13.5"L x 1"W x 1.5"H	90+	1500	750	

Finish Options: Black (BK) White (WT)



ETL25212-BK

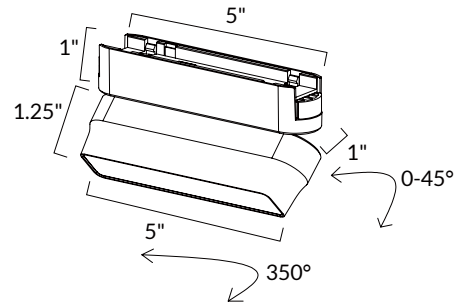

ETL25216-WT

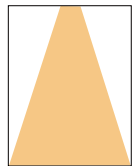
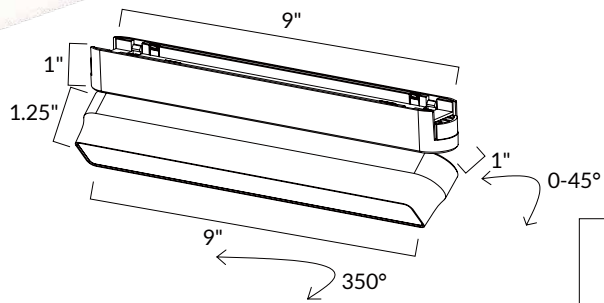

100°

STANDARD LENS  
w/Gimbal

ITEM #	FINISH	LAMPING	DIMENSION	LUMENS			Additional Information
				CRI	INIT.	DEL.	
ETL25212	BK, WT	6W PCB LED 3000K (Inte.)	5"L x 1"W x 2.25"H	90+	600	300	
ETL25216	BK, WT	9W PCB LED 3000K (Inte.)	9"L x 1"W x 2.25"H	90+	900	450	

Finish Options: Black (BK) White (WT)



# TRACK LIGHTS

• Flat Lens Diffuser with even light distribution • Available with adjustable gimbal • 24V LED, 3000K Color Temperature



ITEM #	FINISH	LAMPING	DIMENSION	LUMENS			Additional Information
				CRI	INIT.	DEL.	
ETL24212	BK, WT	6W PCB LED 3000K (Inte.)	5"L x 1"W x 1.5"H	90+	550	450	
ETL24216	BK, WT	9W PCB LED 3000K (Inte.)	9"L x 1"W x 1.5"H	90+	800	675	

Finish Options: Black (BK) White (WT)



ETL23212-BK

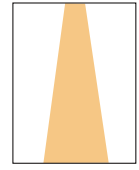
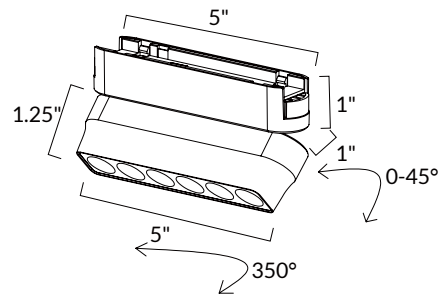

24°

OPTICAL LENS  
w/ Gimbal



ETL23216-WT

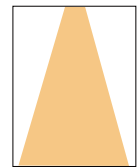
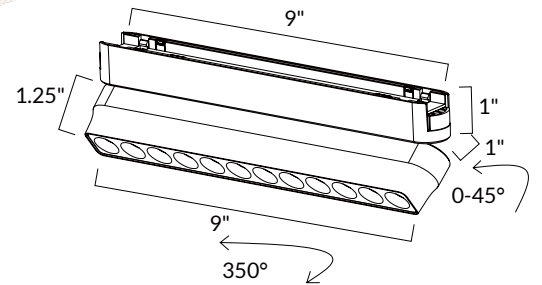

80°

ANTI-GLARE LENS



ETL28212-BK



ETL28216-WT

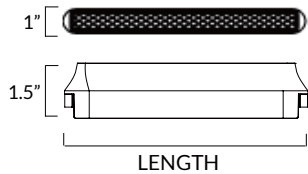

LENGTH

ITEM #	FINISH	LAMPING	DIMENSION	LUMENS		Additional Information
				CRI	INIT. DEL.	
ETL23212	BK, WT	6W PCB LED 3000K (Inte.)	5"L x 1"W x 2.25"H	90+	550 450	
ETL23216	BK, WT	9W PCB LED 3000K (Inte.)	9"L x 1"W x 2.25"H	90+	800 675	
ETL28212	BK, WT	6W PCB LED 3000K (Inte.)	5"L x 1"W x 1.5"H	90+	600 250	
ETL28216	BK, WT	9W PCB LED 3000K (Inte.)	9"L x 1"W x 1.5"H	90+	900 350	

Finish Options: Black (BK) White (WT)



ETL29222  
90° Corner  
Intersection

ETL29212  
90° Flat  
Corner

## TRACK LIGHTS

- Corner Modules Illuminate at 90 degrees
- 24V Low Voltage LED, 3000K Color Temperature • 90 degree single surface module
- 90 degree Wall to Ceiling Module
- Flat PMMA Acrylic Diffusers
- Available in Black and White

## CORNER LIGHTS

### 90° CORNER LIGHT

Single Surface



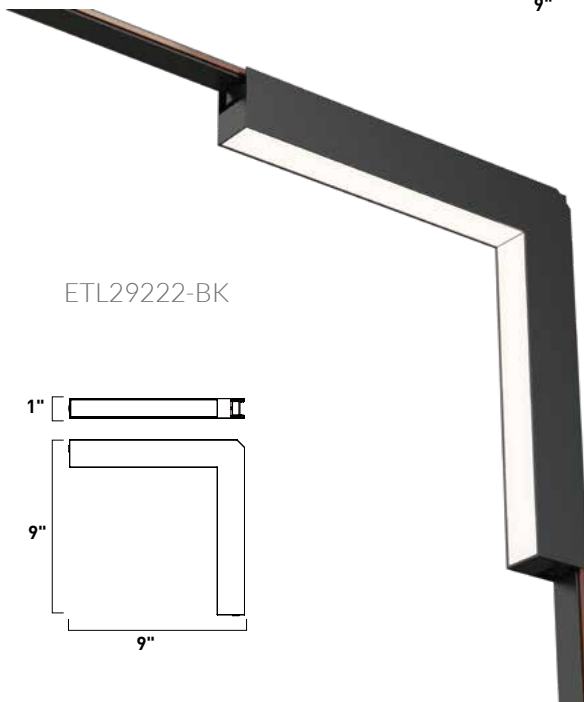
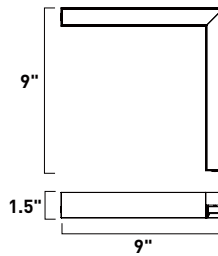



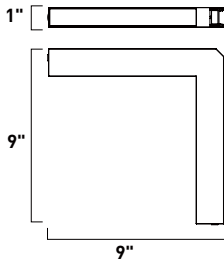

ETL29212-WT



ETL29222-BK



**WALL-TO-CEILING LIGHT** Two Plane Surfaces

ITEM #	FINISH	LAMPING	DIMENSION	LUMENS		Additional Information
				CRI	INIT. DEL.	
ETL29212	BK, WT	15W PCB LED 3000K (Inte.)	9"L x 9"W x 1.5"H	90+	1500:950	   
ETL29222	BK, WT	15W PCB LED 3000K (Inte.)	9"L x 1"W x 9"H	90+	1500:950	   

Finish Options: Black (BK) White (WT)

# SPOT LIGHTS

- Spot Lights to direct light where needed
- Different apertures and lumen packages available
- 24V Low Voltage LED 3000K Color Temperature Adjustable Beam Angle Models
- Available in Black and White with Black interior



**A. ETL21212-BK, -WT**

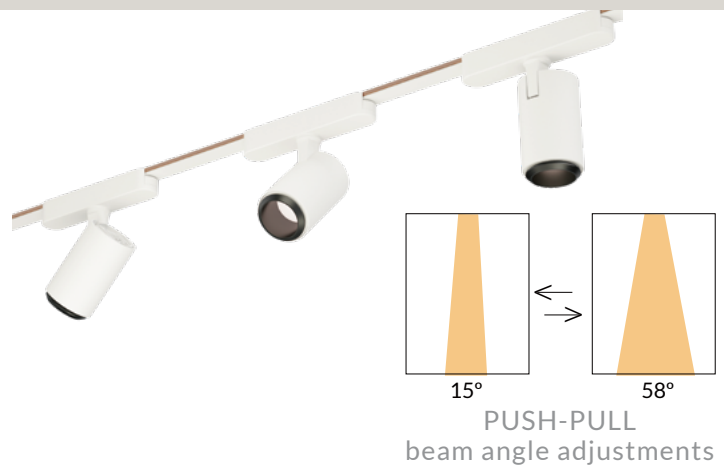

**B. ETL21211-BK, -WT**

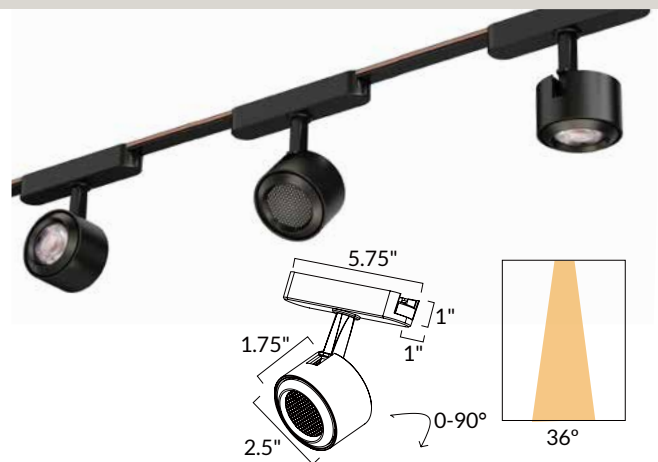

ITEM #	FINISH	LAMPING	DIMENSION	LUMENS			Additional Information
				CRI	INIT.	DEL.	
ETL21212	BK, WT	10W PCB LED 3000K (Inte.)	5.75"L x 2"W x 4.75"H	90+	900	300	
ETL21211	BK, WT	12W PCB LED 3000K (Inte.)	5.75"L x 2.5"W x 4.25"H	90+	1100	850	





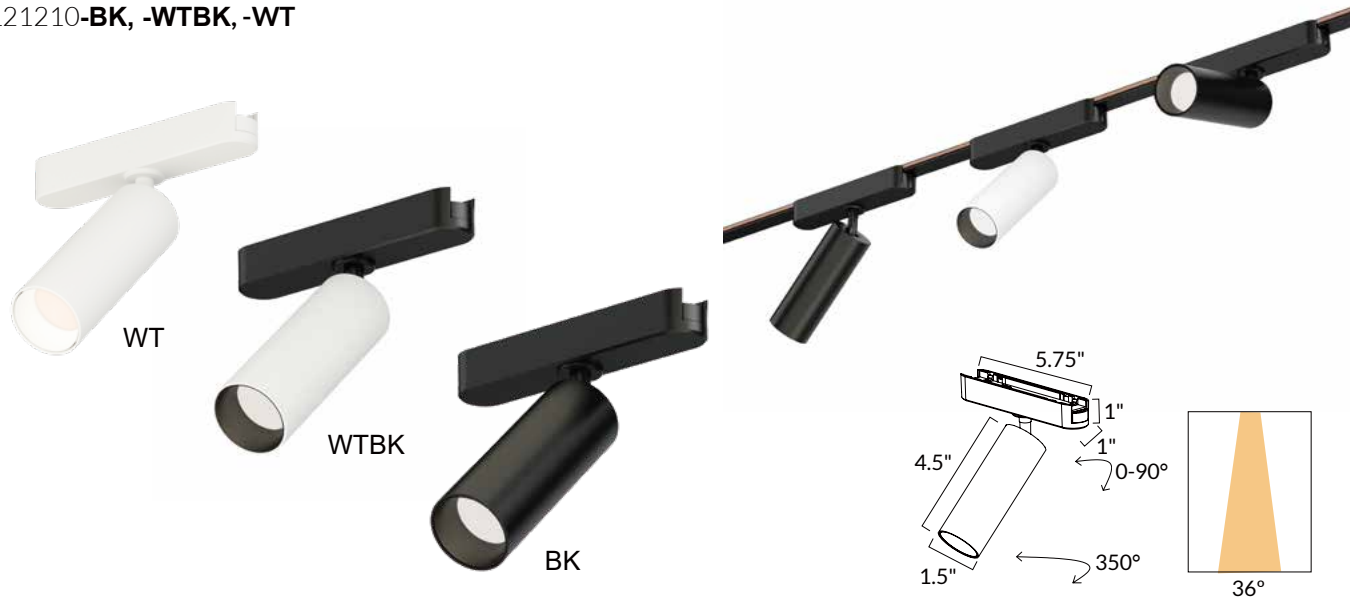



Finish Options: Black (BK) White (WT)

**c. ETL21210-BK, -WTBK, -WT**



**d. ETL21214-BK, -WT**



ITEM #	FINISH	LAMPING	DIMENSION	LUMENS		Additional Information
				CRI	INIT. DEL.	
ETL21210	BK, WTBK, WT	7W PCB LED 3000K (Inte.)	5.75"L x 1.5"W x 5.75"H	90+	650 500	   
ETL21214	BK, WT, 114BK, 114WT	5W PCB LED 3000K (Inte.)	5.75"L x 2.75"W x 4.25"H	90+	450 350	   

Finish Options: Black (BK) White/Black (WTBK) White (WT)



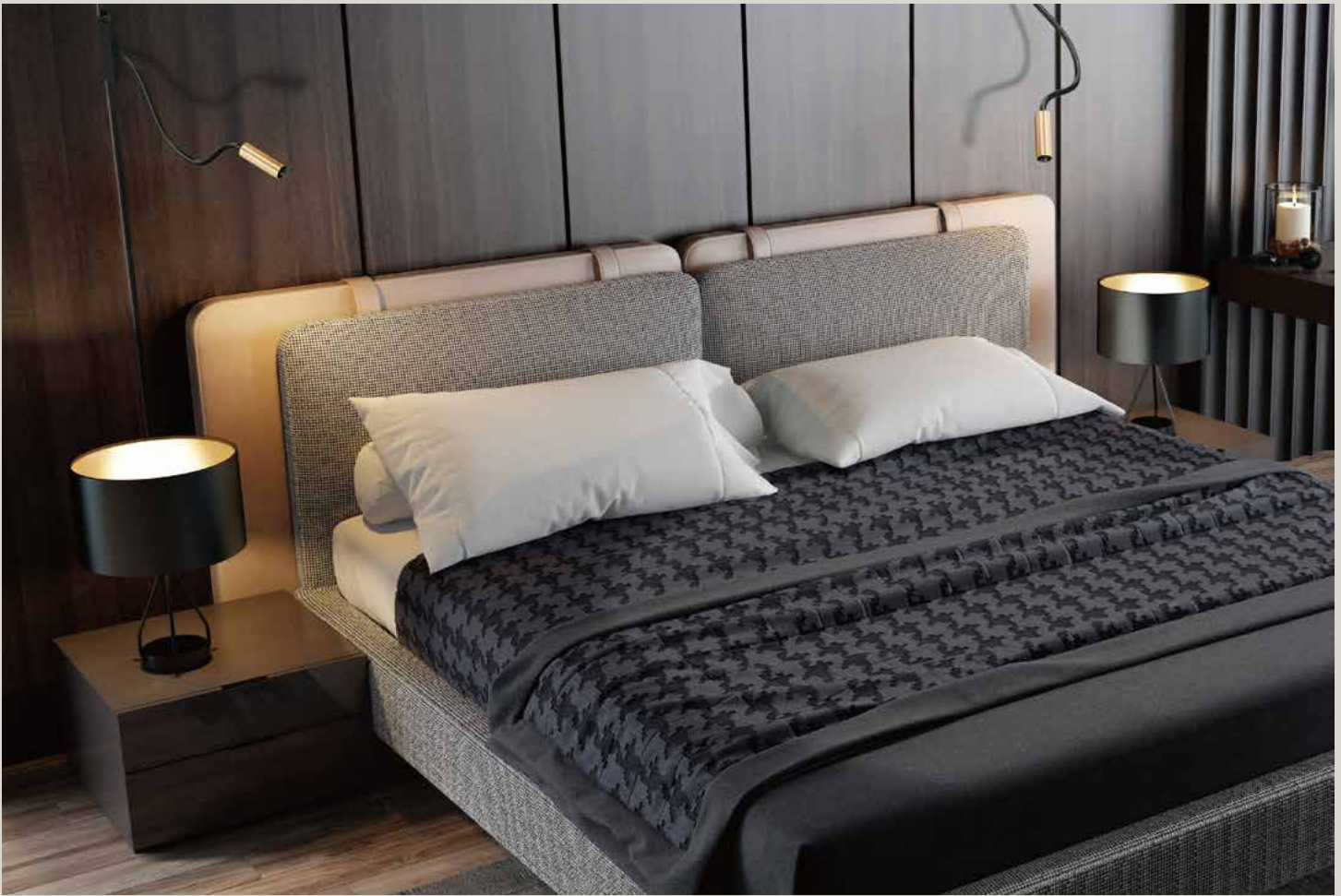





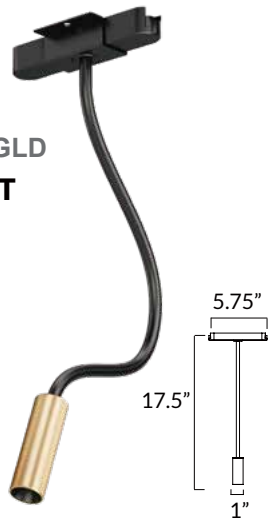

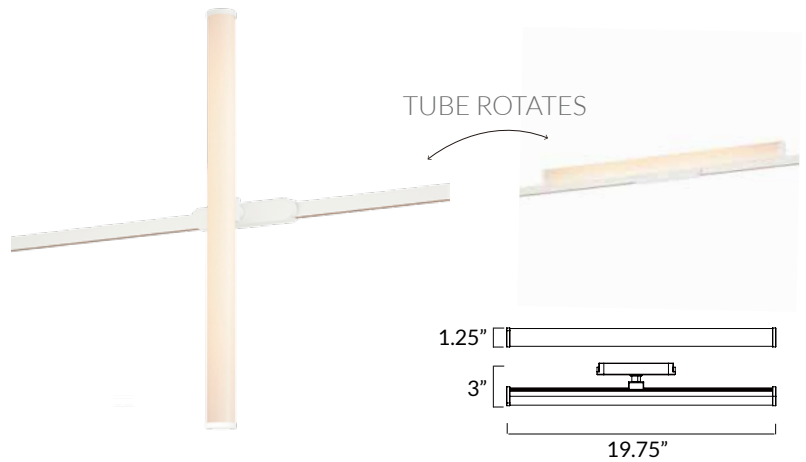

ETL21216-BK, -BKGLD

**READING LIGHT  
FLEXIBLE ARM  
HOLD POSITION  
with touch switch**



ETL21232-BK, -WT  
**TUBE LIGHT**



ITEM #	FINISH	LAMPING	DIMENSION	LUMENS			Additional Information
				CRI	INIT.	DEL.	
ETL21216	BK, BKGLD	2W PCB LED 3000K (Inte.)	5.75"L x 1"W x 17.5"H	90+	200	150	   
ETL21232	BK, WT	12W PCB LED 3000K (Inte.)	19.75"L x 1.25"W x 3"H	90+	1100	850	   

Finish Options: Black (BK) White (WT) Black/Gold (BKGLD)

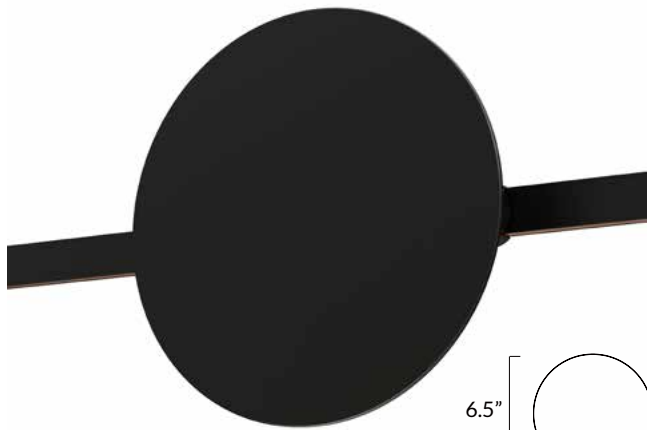

ETL29223

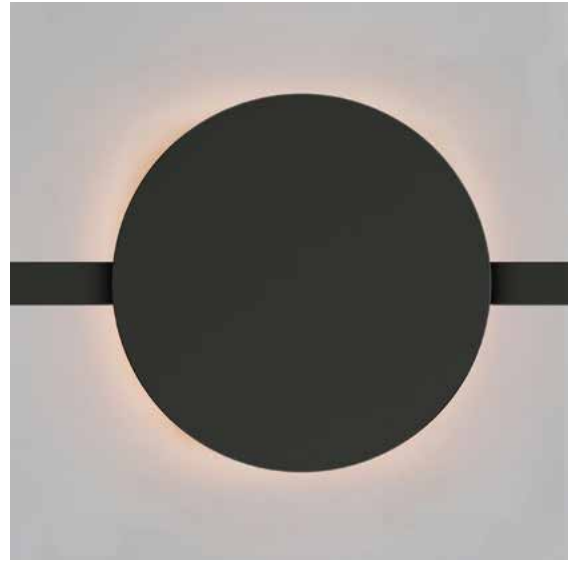
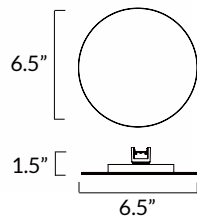







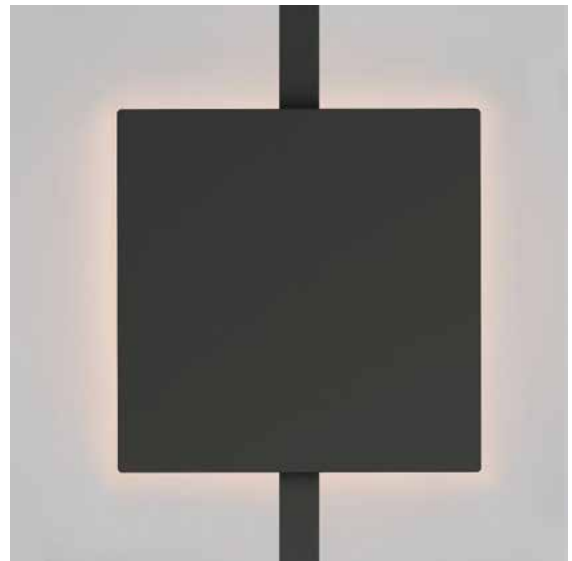
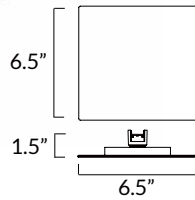

**INDIRECT LIGHT**



ETL29224



ITEM #	FINISH	LAMPING	DIMENSION	LUMENS			Additional Information
				CRI	INIT.	DEL.	
ETL29223	BK	5W PCB LED 3000K (Inte.)	6.5"L x 6.5"W x 1.5"H	90+	450	350	   
ETL29224	BK	5W PCB LED 3000K (Inte.)	6.5"L x 6.5"W x 1.5"H	90+	450	350	   

Finish: Black (BK)



ETL31003-WTBK



ETL31006-WTBK



ITEM #	FINISH	LAMPING	DIMENSION	LUMENS			Additional Information
				CRI	INIT.	DEL.	
ETL31003	WTBK	12W PCB LED 3000K (Inte.)	39.25"L x 1.25"W	90+	600	600	  
ETL31006	WTBK	20W PCB LED 3000K (Inte.)	78.5"L x 1.25"W	90+	1000	1000	  

Finish: White/Black (WTBK)

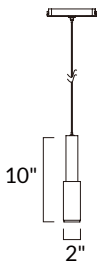

ETL31622-BK, **-NAB**, -WT

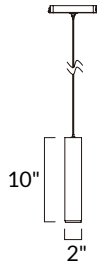

ETL31022-BK, -NAB, -WT

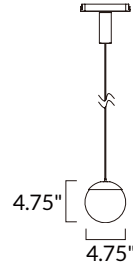

ETL31013-WT, **-WTNAB**

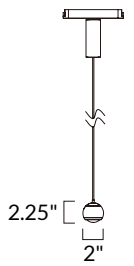
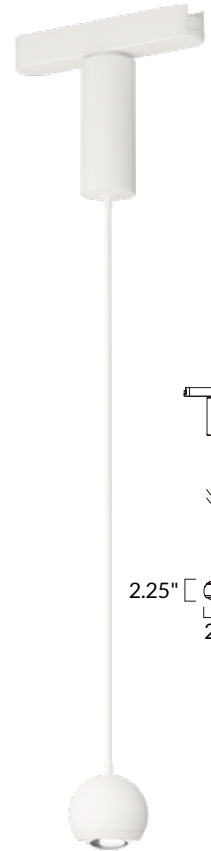

ETL31251-BK, -NAB, **-WT**

ITEM #	FINISH	LAMPING	DIMENSION	LUMENS			Additional Information
				CRI	INIT.	DEL.	
ETL31622	BK, NAB, WT	5W PCB LED 3000K (Inte.)	2"L x 2"W x 10"H, 69"OAH	90+	450	350	LED DIM 124
ETL31022	BK, NAB, WT	5W PCB LED 3000K (Inte.)	2"L x 2"W x 10"H, 69"OAH	90+	450	350	LED DIM 124
ETL31013	WT, WTNAB	5W PCB LED 3000K (Inte.)	4.75"L x 4.75"W x 4.75"H, 63.75"OAH	90+	450	350	LED DIM 124
ETL31251	BK, NAB, WT	5W PCB LED 3000K (Inte.)	2"L x 2"W x 2.25"H, 61.25"OAH	90+	450	350	LED DIM 124

Finish Options: Black (BK) Natural Aged Brass (NAB) White (WT)



# INDEX

---



## SURFACE MOUNTED TRACK

---

	ETRK25080	-BK, -WT	33"L
	ETRK25150	-BK, -WT	60"L
	ETRK25200	-BK, -WT	80"L

## SURFACE MOUNTED CONNECTORS

---

	ETMSC180-2END	-BK, -WT	END-TO-END
	ETMSC90-W2C	-BK, -WT	WALL to CEILING
	ETMSC90-2WALL	-BK, -WT	90° CORNER
	ETMSC90-3TW	-BK, -WT	90° CORNER 3-WAY "T"
	ETMSC90-4XW	-BK, -WT	90° CORNER 4-WAY "X"
	ETMSC-1END	-BK, -WT	END Connector

## POWER SUPPLIES & ACCESSORIES

---

	ETDRV001-24100	-BK, -WT	96W	On-Track Driver
	EDHW-2496	AL	96W	Remote Hardwired Driver
	ESWT898-2460	WT	60W	Dimmable Driver Switch
	ETMSC01	-BK, -WT		Electricity Module & Cover Plate
	ETMSC02	-BK, -WT		Track Cover Plate
	ETMSC03	-BK, -WT		Track Cover Plate
	ETMSC04	-BK, -WT		Splice Box





## TRACK LIGHTS

---

	ETL26212	-BK, -WT	6W	5" FLAT LENS		ETL23212	-BK, -WT	6W	5" ADJUSTABLE OPTICAL LENS
	ETL26216	-BK, -WT	9W	9" FLAT LENS		ETL23216	-BK, -WT	9W	9" ADJUSTABLE OPTICAL LENS
	ETL26218	-BK, -WT	12W	13.5" FLAT LENS		ETL21232	-BK, -WT	12W	TUBE LIGHT
	ETL25212	-BK, -WT	6W	5" ADJUSTABLE FLAT LENS		ETL21216	-BK, -BKGLD	2W	READING LIGHT
	ETL25216	-BK, -WT	9W	9" ADJUSTABLE FLAT LENS					
	ETL24212	-BK, -WT	6W	5" OPTICAL LENS					
	ETL24216	-BK, -WT	9W	9" OPTICAL LENS					
	ETL28212	-BK, -WT	6W	5" ANTI-GLARE LENS					
	ETL28216	-BK, -WT	9W	9" ANTI-GLARE LENS					

## SPOT LIGHTS

---

	ETL21210	-BK, -WTBK, -WT	7W	SPOT LIGHT
	ETL21211	-BK, -WT	12W	SPOT LIGHT
	ETL21212	-BK, -WT	10W	PUSH-PULL BEAM ADJUSTABLE
	ETL21214	-BK, -114BK, -114WT, -WT	5W	SPOT LIGHT

## 90° CORNER LIGHTS

---

	ETL29212	-BK, -WT	15W	90° SINGLE SURFACE
	ETL29222	-BK, -WT	15W	90° WALL-to-CEILING



## INDIRECT LIGHTS/WASHERS

---

	ETL29223	-BK	5W	6.5" ROUND WALL WASHER
	ETL29224	-BK	5W	6.5" SQUARER WALL WASHER

## PENDANTS

---

	ETL31003	-WTBK	12W	39.25" L PENDANT
	ETL31006	-WTBK	20W	78.5" L PENDANT
	ETL31622	-BK, -NAB, -WT	5W	2" PENDANT
	ETL31022	-BK, -NAB, -WT	5W	2" PENDANT
	ETL31013	-WT, -WTNAB	5W	4.75" PENDANT
	ETL31251	-BK, -NAB, -WT	5W	2" PENDANT